

United Nations Economic Commission for Europe (UNECE)  
Convention on Long-range Transboundary Air Pollution (CLRTAP)

International Co-operative Programme on Assessment and  
Monitoring of Air Pollution Effects on Forests (ICP Forests)

---

# MANUAL

on

methods and criteria for harmonized sampling, assessment,  
monitoring and analysis of the effects of air pollution on forests

---

Part XIV

---

## **Sampling and Analysis of Deposition**

Version 2022-1



---

*Prepared by:*

ICP Forests Expert Panel on Deposition

(Nicholas Clarke, Daniel Žlindra, Erwin Ulrich, Rosario Mosello, John Derome, Kirsti Derome, Nils König, Frauke Geppert, Gun Lövblad, Geert P.J. Draaijers, Karin Hansen, Anne Thimonier, Peter Waldner, Arne Verstraeten)

---

Clarke N, Žlindra D, Ulrich E, Mosello R, Derome J, Derome K, König N, Geppert F, Lövblad G, Draaijers GPJ, Hansen K, Thimonier A, Waldner P, Verstraeten A, 2022: Part XIV: Sampling and Analysis of Deposition. Version 2022-1. In: UNECE ICP Forests Programme Co-ordinating Centre (ed.): Manual on methods and criteria for harmonized sampling, assessment, monitoring and analysis of the effects of air pollution on forests. Thünen Institute of Forest Ecosystems, Eberswalde, Germany, 34 p. + Annex [<http://www.icp-forests.org/Manual.htm>]

ISBN: 978-3-86576-162-0



All rights reserved. Reproduction and dissemination of material in this information product for educational or other non-commercial purposes are authorized without any prior written permission from the copyright holders provided the source is fully acknowledged. Reproduction of material in this information product for resale or other commercial purposes is prohibited without written permission of the copyright holder.

Application for such permission should be addressed to:

Programme Co-ordinating Centre of ICP Forests  
Thünen Institute of Forest Ecosystems  
Alfred-Möller-Str. 1, Haus 41/42  
16225 Eberswalde  
Germany

Email: [pcc-icpforests@thuenen.de](mailto:pcc-icpforests@thuenen.de)

Eberswalde, 2022



# CONTENTS

<b>1</b>	<b>INTRODUCTION .....</b>	<b>3</b>
<b>2</b>	<b>SCOPE AND APPLICATION .....</b>	<b>3</b>
<b>3</b>	<b>OBJECTIVES .....</b>	<b>4</b>
<b>4</b>	<b>LOCATION OF MEASUREMENTS AND SAMPLING .....</b>	<b>5</b>
4.1	DEPOSITION MONITORING PROCESS .....	5
4.1.1	Definition of the different deposition types .....	6
4.1.2	Choice of monitoring method .....	7
4.2	SAMPLING DESIGN .....	8
4.2.1	Location of measurement plots .....	8
4.2.2	Information from the plots .....	8
4.2.3	Location and number of replicates .....	9
4.2.4	Guidelines for stands in transition .....	12
4.3	SAMPLING EQUIPMENT .....	12
4.3.1	Equipment for bulk and wet deposition .....	12
4.3.2	Equipment for throughfall monitoring .....	17
4.3.3	Equipment for stemflow monitoring .....	18
4.3.4	Recommendations for a harmonised collector .....	18
4.4	SAMPLING FREQUENCY .....	19
4.5	SAMPLE COLLECTION, TRANSPORT AND STORAGE .....	19
4.5.1	General procedure .....	19
4.5.2	Before sampling .....	19
4.5.3	Storage and transport .....	22
4.6	SAMPLING METHOD FOR THE MEASUREMENT OF MERCURY DEPOSITION .....	23
4.6.1	Sampling design .....	23
4.6.2	Sampling equipment .....	23
4.6.3	Sampling frequency .....	25
4.6.4	Sample collection .....	25
4.6.5	Sample transport and storage .....	25
<b>5</b>	<b>MEASUREMENTS .....</b>	<b>26</b>
5.1	MEASUREMENTS AND REPORTING UNITS .....	26
5.1.1	Selected variables .....	26
5.1.2	Analysis .....	30
5.1.3	Reception at the laboratory, initial checks and temporary storage .....	30
5.1.4	Pre-treatment of the samples .....	31
5.2	QUALITY ASSURANCE (QA) AND QUALITY CONTROL (QC) .....	31
5.2.1	QA in the field .....	31
5.2.2	QA in the laboratory .....	32
<b>6</b>	<b>DATA HANDLING .....</b>	<b>34</b>
6.1	DATA SUBMISSION .....	34
6.1.1	Procedures and forms .....	34
6.1.2	Submission of data from pooled sampling periods and periods without any sample quantity .....	34
6.2	DATA VALIDATION .....	35
6.2.1	Guidelines for the treatment of missing values .....	35
6.3	TRANSMISSION TO CO-ORDINATING CENTRES .....	35
6.4	DATA PROCESSING GUIDELINES .....	35
6.5	DATA REPORTING .....	36

---

6.6	USE OF BULK OPEN FIELD AND THROUGHFALL DEPOSITION DATA IN REPORTS.....	36
<b>7</b>	<b>REFERENCES .....</b>	<b>37</b>
<b>8</b>	<b>ANNEX .....</b>	<b>39</b>
	ANNEX 1: CANOPY BUDGET MODELS.....	39
	ANNEX 2: PUBLICATIONS LINKED TO COLLECTOR AND SAMPLING DESIGN .....	50
	ANNEX 3: SIMPLE GUIDELINES FOR CALCULATIONS .....	54
	ANNEX 4: PROCEDURES FOR ENSURING HIGH QUALITY ANALYTICAL RESULTS.....	56
	ANNEX 5: LIST OF ISO AND CEN METHODS .....	69
	ANNEX 6: OXIDATION OF MERCURY – ADDITION OF BROMINE CHLORIDE AND HYDROCHLORIC ACID .....	70
	ANNEX 7: INTERPRETATION OF THE THROUGHFALL DATA .....	71
	ANNEX 8: MINOR CHANGES AFTER 2022 .....	72

# 1 Introduction

In 1994, the implementation of the Pan-European Programme for the Intensive Monitoring of Forest Ecosystems started. Within this programme, deposition is one of the key factors in the causal chain between emission of air pollutants and effects in forest ecosystems. It is therefore necessary to quantify atmospheric deposition at the Intensive Monitoring sites (Level II). A general approach for deposition monitoring, including both European and national level activities, is given in Figure 1. It shows that the definition of needs, methods and quality assurance at the European level should directly influence national activities, starting with the choice of the plot and ending with data validation and evaluation.

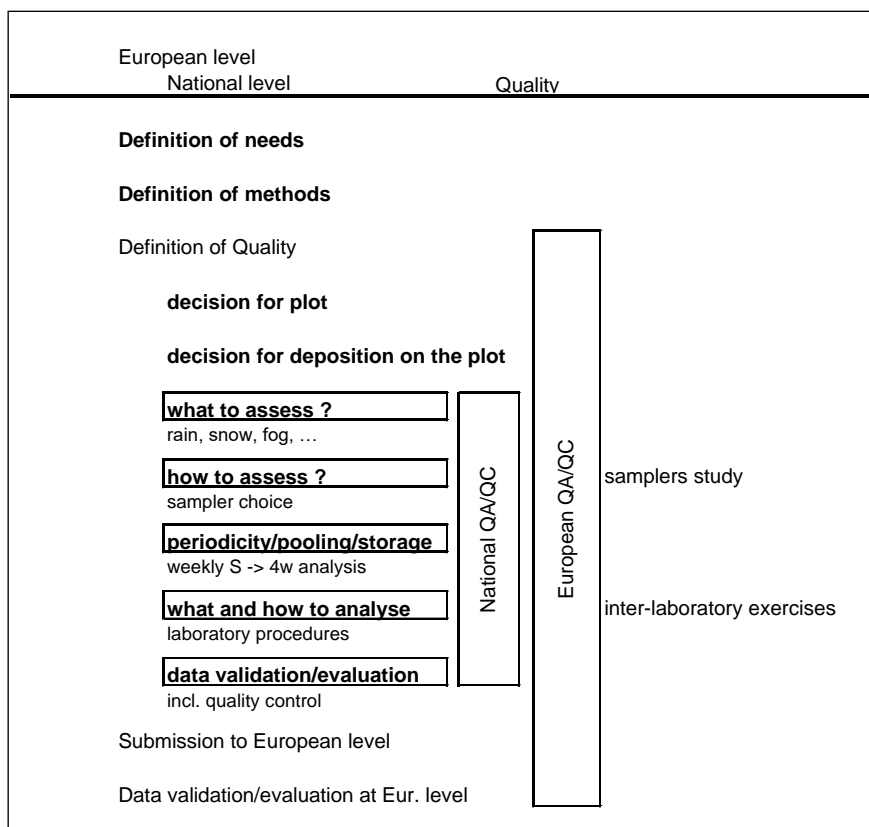

Figure 1: General approach of the deposition monitoring activities on the European and national level and of the associated quality assurance/quality control (QA/QC) programme.

## 2 Scope and application

The objective of this part of the Manual is to provide procedures for measurement of ion and total element concentrations in throughfall, stemflow, bulk and wet deposition (Table 1) in order to harmonise the deposition estimates within ICP Forests and to create comparability with other deposition measurements within UNECE programmes.

Harmonization is necessary to permit trans-national studies on status and trends of atmospheric deposition. National Focal Centres and their scientific partners participating in the UNECE ICP Forests programme are obliged to follow the methods described here and achieve the data quality objectives for determination of ion and element concentrations in stemflow, throughfall, bulk and wet deposition on the plots given in Table 1.

**Table 1: Mandatory parameters for deposition sampling on standard Level II and Level II core plots, with their data quality objectives (DQOs) (from Marchetto et al. 2006).** The DQO are defined with precisions (95% significance level) for values above and below a threshold and include all type of errors such as plot design, field sampling, sample storage and laboratory analyses.

Variable	Reporting unit	Threshold	DQO, threshold >	DQO, threshold <
pH	pH unit	5.0	±0.2 units	±0.1 units
Conductivity	µS/cm	10	±10%	±20%
Ca	mg/L	0.25	±15%	±20%
Mg	mg/L	0.25	±15%	±25%
Na	mg/L	0.5	±15%	±25%
K	mg/L	0.5	±15%	±25%
NH <sub>4</sub> -N	mg N/L	0.25	±15%	±25%
SO <sub>4</sub> -S	mg S/L	1.0	±10%	±20%
NO <sub>3</sub> -N	mg N/L	0.5	±15%	±25%
Cl	mg/L	1.5	±15%	±25%
Alkalinity	µeq/L	100	±25%	±40%
Total N	mg/L	0.5	±20%	±40%
DOC	mg/L	1.0	±20%	±30%

### 3 Objectives

The objective of deposition monitoring on the Level II plots is to estimate atmospheric deposition (concentrations, amount of deposition, fluxes) and soil loads at the sites, on which intensive monitoring is performed and to contribute to the understanding and quantification of deposition processes to forest ecosystems of Europe. The specific objectives are as follows:

- (1) Quantification of annual deposition of acidity, all forms of nitrogen and precipitation by the throughfall method with a precision of ±30% (95% significance level).
- (2) Detection of a temporal trend of the deposition on a plot. Detect a change of ±30% (3% per year) within 10 years (95% significance level).



## 4 Location of measurements and sampling

### 4.1 Deposition monitoring process

Deposition monitoring can be divided into 12 major activities. All these activities are linked to specific QA/QC procedures. All the QA/QC procedures aim, with their feedback, to improve the quality of the whole monitoring process and therefore also the quality of the published data. The flowchart of the deposition monitoring process is defined in detail in Figure 2. In the following chapters the different activities are defined.

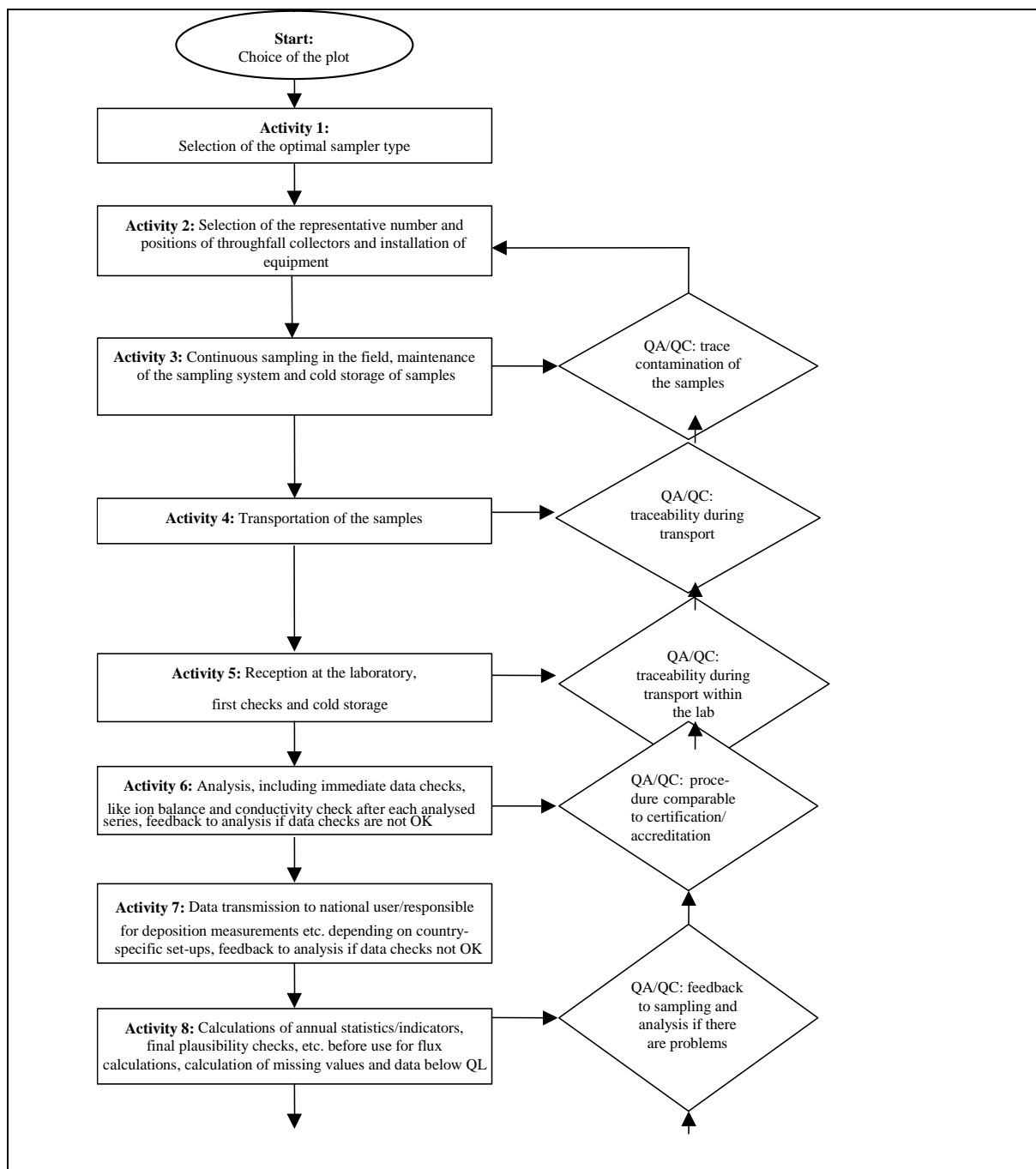

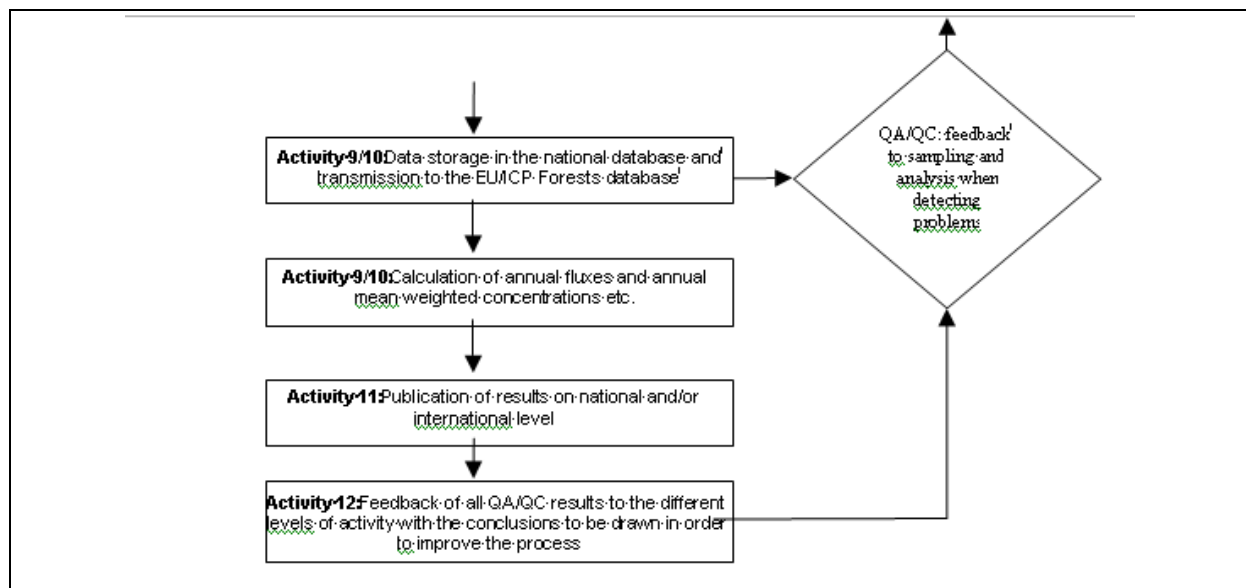

**Figure 2: Flowchart of the deposition monitoring process in a country/part of a country.** The next steps are shown on the following page. The different activities are described more in detail in the text. QL = quantification limit.

#### 4.1.1 Definition of the different deposition types

Rain and snow are collected in the open field close to the forest stand. The collectors may be open all the time (bulk collector) or open only during periods of precipitation (wet-only collector).

##### 4.1.1.1 Wet-only deposition

Wet-only collectors open automatically at the onset of precipitation by the use of a sensor, and close at the end after rain has stopped, thus avoiding the collection of particles and gases during dry periods. This method can be used to determine the fluxes of dissolved components from the atmosphere in rain, snow and hail in the open field. The advantages are that it gives valuable information on the chemistry of atmospheric deposition and on long range transport of air masses. However, it needs electrical power and maintenance and does not work correctly in cases of heavy snow.

##### 4.1.1.2 Bulk deposition

Bulk deposition is sampled with a continuously open plastic funnel connected to a sample bottle. The funnel also collects parts of particulate and gaseous deposition during dry periods. Contributions from occult deposition are also included. This method can also be used to determine the fluxes of dissolved components from the atmosphere in rain, snow and hail in the open field. When bulk deposition is used in the estimation of total atmospheric deposition to the forests, estimation errors are introduced. This is because canopy exchange models need wet-only deposition as one of the input parameters. However, the choice of bulk measurements over wet-only measurements may be necessary because of financial constraints. The advantages compared with wet deposition monitoring are that it is cheap and simple, electrical power is not needed, and maintenance is low. However, the method is very sensitive to dust from neighbouring areas. In regions with calcareous soils, bulk deposition gives incorrect information on the pH and chemistry of atmospheric deposition.

##### 4.1.1.3 Dry deposition

Dry deposition concerns mostly the forest canopy, but also at a minor level bulk deposition in the open field. Fluxes of gases and particles from the atmosphere during dry periods, due to gravity (sedimentation), impaction, and interception are determined. The values are strongly

influenced by the type of surfaces (leaves, needles, rocks, water, etc.), the humidity of surfaces, and the macro- and micrometeorology (stomata closure).

The measurement of dry deposition is difficult and expensive; there are several techniques, but all have their limitations. Some models, e.g. the EMEP or EDACS models or some national models, evaluate dry deposition over Europe.

#### **4.1.1.4 Occult deposition**

Occult deposition comes from fog, rime, mist and cloud water. Although amounts deposited are relatively small, concentrations in occult deposition can be very high, which could lead to direct impacts.

#### **4.1.1.5 Throughfall deposition**

Throughfall is deposition sampled beneath the forest canopy and containing bulk + leached + dry deposition-adsorbed ions. Contributions from occult deposition are included. Together with stemflow, throughfall gives an estimate of the deposition to the forest floor. Like bulk deposition, it is cheap, simple and low-maintenance.

#### **4.1.1.6 Stemflow deposition**

Stemflow is deposition sampled on stems and contains precipitation, occult deposition and leachates from the bark and leaves. In beech forest, stemflow is an important contributor to the deposition reaching the forest floor.

#### **4.1.1.7 Total atmospheric deposition**

Wet-only + dry deposition to the canopy excluding internal ion exchange processes. Throughfall + stemflow is considered to be equal to total deposition only for sodium and sulphur.

### **4.1.2 Choice of monitoring method**

Several methods can be used to measure or estimate deposition to forests. However, only one of them, the throughfall method, meets the requirements of being relatively simple and economically feasible for most countries. Throughfall can also be used in complex terrain, such as forested areas on exposed heights and slopes. Another advantage is that contributions from occult deposition are included in the throughfall deposition. In addition to throughfall, wet deposition (deposition via precipitation) or bulk deposition in the open field should be measured and, for some types of forest stands, even stemflow.

The main drawback of the throughfall method is the interaction between the canopy and the throughfall water for nitrogen, potassium, calcium, magnesium, manganese and protons. However, the results from throughfall monitoring can still be used as a valuable indicator for the nitrogen and base cation deposition to the forest. Throughfall deposition can give information on the lower limit of the true deposition of nitrogen and the upper limit of true deposition of base cations other than sodium. For sodium and sulphur the canopy uptake and leaching is considered to be negligible and consequently the throughfall flux is used to estimate the total deposition.

To estimate the dry deposition of nitrogen and canopy uptake of nitrogen compounds, dry deposition can be estimated using air concentrations of nitrogen compounds and meteorology as input data, or canopy budget models (Annex 1) can be applied. To determine deposition of base cations, canopy budget models have to be applied to differentiate the contributions from leaching and dry deposition in the net throughfall (throughfall plus stemflow minus wet deposition).

The dry deposition contribution varies geographically. In polluted areas and in areas subject to impact from Saharan dust, dust from anthropogenic sources or sea salt, the contribution of dry deposition may be significant, while in other areas it may be small. As for throughfall, the precipitation amount in the bulk collectors is determined by measuring the sample volume. In addition to that, in the open field the use of a standard meteorological (manual) rain gauge is recommended in order to obtain an independent control of the precipitation amount at the sampling site.

Throughfall deposition measurements should necessarily be made on the plot itself in order to be representative for the plot. Caution must be taken not to cause any damage to the plot. Wet or bulk deposition should be measured in the open field close to the plot. The measurements should in no way interfere with other measurements of soil and vegetation. The maximum acceptable distance depends on the emission situation in the vicinity of the forest and on the orientation in hilly or mountainous terrain. There must, however, be no influence from local point emission sources. The measurement site must not be influenced by climatic conditions other than those, which are found on the forest plot.

## **4.2 Sampling design**

### **4.2.1 Location of measurement plots**

Deposition monitoring must be representative for the site and it is recommended that measurements should be made, as far as possible, on all Level II sites. If deposition is only measured on a selection of plots, it is recommended to choose them in such a way that they are spatially well distributed over the country. Preference should be given to the following points:

Choose the plots in such a way that they are spatially well distributed over the country so that different deposition ranges can be observed according to the geo-climatic and emission situations.

Each plot should correspond to the main species or main mixture of species, the mean climatic conditions and ecosystem type within the concerned forested area.

Homogenous stands, representative for regional environmental climate, far from local sources (industry, farms, traffic, etc.)

Prefer those plots on which other important monitoring activities take place.

### **4.2.2 Information from the plots**

The plots on which deposition is measured must be described in detail. Some of the information is already included in the descriptions of the forest monitoring plots (longitude, latitude, altitude, exposure, tree species, etc.) Other information needs to be documented with special consideration to the deposition situation (exposure to any smaller local or regional emission sources and local land use location in relation to forest edges etc.) For interpretation and understanding of the deposition processes, information on factors such as canopy roughness, height of the stand, structure, leaf area index, evolution of the stand (density), vitality, biotic stresses (insect plagues) and several meteorological parameters etc. is valuable (see monitoring programmes on crown condition, increment assessment).

If monitoring sites or procedures are changed, parallel stations or parallel equipment should be run for a sufficient long period (3-12 months depending on the type of change) in order to ensure the consistency of the time series.

### 4.2.3 Location and number of replicates

Preliminary studies should be carried out to determine the number of collectors required and their location within the forest stand, in order to obtain a representative sample of the deposition parameter being measured. Statistical analysis of the measurements should be made for each plot in order to ensure that the sampling procedure meets the fixed criteria.

#### 4.2.3.1 Location and placing criteria for bulk and wet-only collectors

Information on placing of precipitation collectors can be found in the EMEP manual (EMEP 2001) and the manual for the GAW precipitation chemistry programme (WMO 2004). The collectors should be set up on an open field site at the same altitude and exposure as the forest plot (ICP Integrated Monitoring 1998), and considering the prevailing wind directions. Level areas are preferable, although slopes of up to  $\pm 15\%$  are acceptable. Sudden changes of slope within 30 m of the collector should be avoided.

There should be no obstacles (trees, topographical features etc.) above  $30^\circ$  from the rim of the precipitation collector. This means that the distance from the collector to the obstacle should be twice the height of the obstacle. Topographical features, buildings or hedges giving rise to updraughts or downdraughts should be avoided. Any object over 1 m high that can deflect wind should not be located within 5 m of the collector. If fencing is used (e.g. to prevent damage from animals), it must be put up in accordance with these requirements. The height of surrounding vegetation should not be higher than half the height of the collector, measured from the ground to the sampling orifice (WMO 2004). In areas with high snow accumulations, a platform may be used to raise the collector.

It is important that local sources of soil dust (gravel roads, farmyards or tilled agricultural fields) and ammonia (from farming) are avoided. Contamination from local residential heating with wood, peat or coal may also occur: potassium is an indicator of such contamination. If heavy metals are to be determined, local metal sources (e.g. metal surfaces, building materials, paint) must also be avoided. Distances of 100 m to 2 km from local sources of contamination are recommended by EMEP (2001).

#### 4.2.3.2 Location and placing criteria for throughfall collectors

Throughfall measurements should be made in such a way that the results are representative for the plot area and should provide information on the coefficient of spatial variation by parameter. This means that a sufficiently large number of collectors should be used and the collectors should be placed in such a way that the variation is covered.

##### 4.2.3.2.1 Number of throughfall collectors to be used

A throughfall collector samples only the small area where it is placed. In order to take into account the large local variations in throughfall deposition in a forest stand, a sufficiently large number of collectors must be used. Table 2 presents the minimum number of collectors (funnels of 100-600 cm<sup>2</sup>) to be used on sample areas up to 2500 m<sup>2</sup> (minimum 500 m<sup>2</sup>). These numbers guarantee, according to the currently available knowledge in international literature (see Annex 2), measurements with at least 20% error of the mean with a 90% confidence interval for most of the measured ions and for precipitation quantity. The number of collectors is dependent on the forest type and increases with increasing heterogeneity (due to e.g. species mixture, stand density, nearness to forest edges, precipitation types etc.) If gutters are used, the number and length of gutters must be sufficient to cover the variability of the stand deposition. Far fewer scientific studies exist for gutters and therefore no guidelines can be given here, which hints at the necessity of local studies.

**Table 2: Recommended number of throughfall collectors (funnels of 100-600 cm<sup>2</sup>) needed in order to reach 20% error and a 90% confidence interval in most cases for plot areas of up to 2500 m<sup>2</sup>, depending on forest type.** The numbers are from different publications (see Annex 2, [www.icp-forests.org/DocsDepo/Rovan05\\_Publicat\\_samplers.doc](http://www.icp-forests.org/DocsDepo/Rovan05_Publicat_samplers.doc)).

Forest type	Minimum number of collectors
Very homogenous single species conifer forest (systematically planted, no openings)	20
Very homogenous single species broad-leaved forest (systematically planted, no openings)	25
Heterogeneous single species (e.g. uneven aged) and mixed forest of 2 or more tree species, whether they are conifers or not, with small openings	35-40
Heterogeneous single species (e.g. uneven aged) and mixed forest of 2 or more tree species, whether they are conifers or not, with big gaps	> 40

Guidance on the number, of how many and how large collectors are needed should be obtained in a study on the plot in question. It is necessary to carry out studies of the variations within the plot and repeat these following major structural changes (e.g. thinning, storm damage, fire). In such studies a large number of collectors should be used. Critical parameters should be measured during these studies such as total nitrogen, ammonium, nitrate and conductivity. The study should concentrate on throughfall deposition and not on volume or concentration only. The criterion for deciding the number of collectors is at present that deposition for all major ions on the plot should be estimated within  $\pm 20\%$  of the mean. Only if such studies cannot be made, e.g. for financial reasons, should Table 2 be used as a guideline for the minimum requirements.

The decision on the number of sampling points necessary can also be made using principal component analysis (e.g. Houston et al. 2002) or by optimising the coefficient of variation (maximum 20%) and 90% confidence interval. This check can even be done after several years of monitoring, but it is essential to be able to define the error induced in the deposition estimates by the chosen field approach.

#### 4.2.3.2.2 Spatial distribution of throughfall collectors

The collectors should be spatially representative of the area of the whole Level II plot (and not only the sub-plot).

It is necessary to assess the spatial distribution of the collectors in connection with the number of collectors to be used on a given study area.

It is therefore recommended that the spatial representativity of throughfall deposition (and not concentration) will be checked for each plot for a minimum of one year (depending on the period covered by rainfall) with a high number of collectors (e.g. 30-40). On plots on which precipitation in the form of snow contributes to more than 20% of the annual throughfall, the spatial arrangement study should be done for both snow and rain periods, i.e. during the vegetation and winter periods. Snow type and quality is quite different during the winter and the frequency of the different snow types depends on latitude and longitude. Few scientific studies on the variability of snow under the forest cover exist, which hints to this necessity of local studies.

Neither a systematic nor a random approach can be considered as the only solution: both are valid. A systematic distribution is one that is ordered and regular (see below for an example). A random distribution is not the same as subjective: if a random design is chosen, it has to be random in a statistical sense, i.e. every part of the plot has an equal chance of being selected. Systematic or random distribution can be used, or even better a combination

of both (Figure 3). A combination of systematic and random distributions has the big advantage of covering the whole plot used for deposition monitoring. Thus, the plot area is divided in quadrates of equal sizes (length to be adapted to the size of the study area). Within each quadrate, the sample points are chosen randomly. This couples the advantages of random and systematic sampling. As is the case for random sampling, it does not violate the assumption of independence between sampling units. At the same time, like the systematic sampling, it takes into account the spatial dependency of the data, enabling an even distribution of the collectors on the plot area (Ferretti and Mosello 2002). Further examples of studies are given in the reference list at the end of this document (Annex 2). Distribution of collectors should avoid systematic errors, e.g. placing of collectors equidistant to the stems of neighbouring trees.

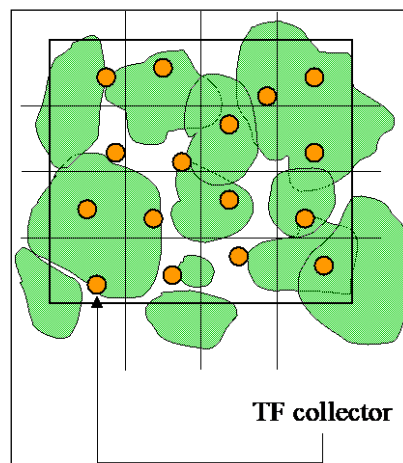

**Figure 3: Combination of systematic and random sampling on the same plot or random selection of sites within previously selected equally-sized parts of the plots.**

#### **4.2.3.3 Location and placing of stemflow collectors**

Stemflow measurements are mandatory in beech stands and optional in all other stands. Stemflow may however give important contributions for other deciduous stands and for young spruce stands. Where it is not clear whether stemflow should be measured or not, it is recommended to verify its importance to the total deposition at each plot for a period of at least one year. As for throughfall, stemflow measurements should be made in such a way that the results are representative for the plot area and should provide information on the coefficient of spatial variation by parameter. Thus, a sufficiently large number of collectors should be used and the collectors should be placed in such a way that the variation is properly covered.

##### **4.2.3.3.1 Number of stemflow collectors to be used**

Variations in stemflow are larger than for throughfall, depending on the variation in tree species and tree size at the plot. To cover this variability, a minimum of 20 to 60 stemflow collectors would be necessary, but in many cases this is not feasible in practice. Therefore, given the fact that in most cases stemflow on beech represents “only” up to 15-30% of the total stand precipitation and even less for deposition of different ions, the compromise is to recommend 5 to 10 stemflow collectors. The recommended study can also identify whether stemflow measurements are important in the final sampling programme and if so, how many and which types of trees shall be sampled. It is also possible to connect a number of trees to one collector. When tipping buckets are used to record water amounts, a greater number of trees can be included in the sample.

Guidelines for calculating quantities from stemflow volumes are given in Annex 3.

#### 4.2.3.3.2 Spatial distribution of stemflow collectors

The spatial distribution of the stemflow collectors will rather be influenced by the presence of trees representative of the diameter class distribution of the species in the plot. Stemflow collectors shall be attached to trees growing on the plot. If the tree sizes differ, stemflow shall be sampled on trees of different basal area or canopy size classes, proportionally to their frequency distribution. The stemflow collectors shall be placed around the stem of the trees between 0.5 and 1.5 meter above ground level. As for throughfall sampling, care should be taken not to interfere with other monitoring activities on the plot and not to damage the trees.

#### 4.2.4 Guidelines for stands in transition

In case the stand where the monitoring plot is situated reaches the age of final cutting, or the stand is destroyed by e.g. storm or pest infestation, monitoring activities need to be either (i) moved to a new location, or (ii) remain in the same location in regenerated stand. If the plot is moved to a new stand the same rules as establishing a new monitoring plot apply (see Manual Part II on Basic design principles for the ICP Forests monitoring networks, Ferretti et al. 2020). If the monitoring continues on the same location in an artificially or naturally regenerated stand, deposition sampling needs to be adapted to the new situation. Sampling of bulk deposition in the open field must always be continued. Throughfall sampling could be temporarily stopped until trees reach the average height of 1.3 meters. It is however advised to continue throughfall sampling even if new trees are still smaller, because the collected data could give valuable information on the difference with the open field under conditions that are more or less comparable. In case that the new stand is heterogeneous, the number of throughfall collectors should be temporarily increased. Stemflow sampling could be temporarily stopped until new trees (beech only) reach a diameter of >5 cm.

### 4.3 Sampling equipment

The following chapter outlines the equipment for the measurement of deposition including all main elements and described heavy metals. For the measurement of mercury (Hg) deposition special equipment and handling of the samples is needed because of very low mercury concentrations and therefore contamination problems. Due to its differing and newly developed design and methodology, the measurement of mercury deposition will be described in chapter 4.6.

#### 4.3.1 Equipment for bulk and wet deposition

##### 4.3.1.1 Bulk precipitation collectors for rain

For bulk sampling, all countries should use a type of collector, which is comparable among countries concerning some minimum requirements, developed below. For the liquid (e.g. rain) and the solid phase (e.g. snow) different types of collectors may be used. A minimum of three replicates is necessary.

The design of this collector should as a minimum conform to:

the definition of the World Meteorological Organisation (WMO) minimum requirements for correct precipitation quantity measurements.

the needs for the stability of the sample for chemical analysis (no contamination, no absorption of compounds, no excessive heating or light).

These minimum requirements are defined below.



#### 4.3.1.1.1 Standard precipitation gauge according to WMO definition

"The commonly used precipitation gauge consists of a collector placed above a funnel leading into a container where the accumulated water and melted snow are stored between observation times" (WMO, 2008).

##### *Collecting area*

"The size of the orifice of the collector is not critical for liquid precipitation, but an area of at least 200 cm<sup>2</sup> is required if solid forms of precipitation are expected in significant quantity. An area of 200 to 500 cm<sup>2</sup> will probably be found most convenient" (WMO, 2008). The sampling area must be horizontal, as the collecting area will otherwise be reduced. The collecting surface should be known with a maximum margin of error of  $\pm 2\%$ . The collecting surface should be in form of a circle (200 cm<sup>2</sup> = diameter of 16 cm; 500 cm<sup>2</sup> = diameter of 25.2 cm). In areas with high wind, a larger number of collectors with a smaller surface area are preferable, because under-catch as a result of aerodynamic blockage during high wind speed rain events will be greater with a larger collecting area (Bleeker et al. 2003). In areas where the precipitation is generally low and sampling frequency is high (due to eventual evaporation), a bigger funnel surface is recommended. The collecting surface has to be verified at least once a year on all devices. The surface area of all collectors should meet the criteria of 2% variation coefficient.

The true collecting area cannot be assumed to be identical to the theoretical value (e.g. as given by the manufacturer or assumed in the case of home-made collectors), but must be measured and documented. Because collectors may expand or shrink as a result of weather conditions, it is recommended to check the size of the collecting area at least once a year (Bleeker et al. (2003) recommend twice a year). To estimate the true collecting area, half of the rim area should be included, as droplets falling on the rim are assumed to splash into the container 50% of the time.

##### *Rim*

"The rim of the collector should have a sharp edge and should fall away vertically on the inside, and be steeply bevelled on the outside; the design of gauges used for measuring snow should be such that any narrowing of the orifice caused by accumulated wet snow about the rim is small" (WMO 2008). The rim must be of hard material to minimise changes in the collecting area. Both the shape and the width of the collector rim will influence the extent of aerodynamic blockage. Sharp rims induce more turbulence than flat rims, while thick rims lead to greater undercatch than thinner rims (Sevruk et al. 1994). A round rim probably induces less turbulence than a flat rim (Bleeker et al. 2003).

##### *Shape*

WMO manuals recommend that the upper part of the collector should be very sharp and should go down vertically in the form of a cylinder. Collection vessels with sloping sides have to be avoided in order to prevent any loss of precipitation due to splashing especially during precipitation events, during which rain droplets impact with high kinetic energy. The vertical part of the collector should be deep enough to avoid any ejection or loss by wind of the incoming precipitation. Figure 4 shows schematically the required design, i.e. a funnel.

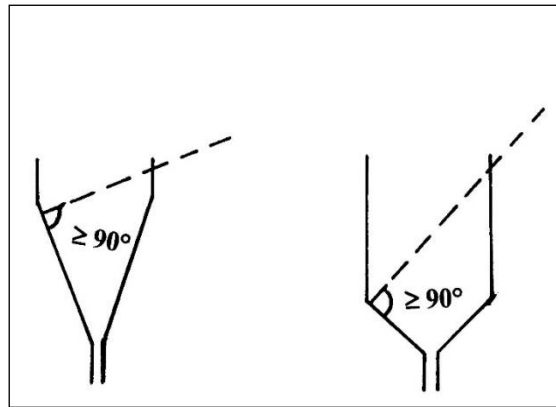

**Figure 4: The only satisfactory design for precipitation quantity sampling (after WMO, 1990).**

#### *Material*

The upper part of the collector should have smooth surfaces, with no breaks or ridges in the connections in order to limit evaporation losses and ensure rapid water flow. The material, of which the collector and its containers, tubes, glue, bird wires etc. is made, must not interact with the sample solution. Polyethylene is a suitable material recommended for the studies of macro-ions. A test for the release of solutes has to be done for all new material before use in the field and laboratory (e.g. filtration). For sampling heavy metals, separate polyethylene equipment, which is acid washed at the laboratory before use, must be used. Polyethylene can become brittle when exposed to sunlight and may need to be replaced annually (EMEP 2001). Tetrafluoroethylene and tetrafluoroethylene-fluorinated ethylpropylene copolymer are other materials that are recommended by EMEP (2001). Metals or materials with unknown chemical properties should not be used.

#### *Height above ground level*

In order to avoid contamination of the samples, the rim of the collector should be 1.0-1.5 m above ground level. The sampling area must be horizontal; the collecting area will otherwise be reduced.

#### *Sieves and filters*

In order to avoid larger objects (insects, parts of leaves or needles, etc.) from falling into the bottle and contaminating the sample, for instance a polyethylene net (mesh width 1 mm has been recommended, Bleeker et al. 2003) sieve or other inert sieves (aquaristic filter fleece) should be placed at the top of the neck of the collector. The design of the sieve should be such that eventual debris is not concentrated in the neck of the collector forcing all rain to pass through the accumulating debris. The sieve must not impede the water flow: sieves that are not fixed in position are therefore recommended (Bleeker et al. 2003). It is possible to use a filter afterwards, with a pore size small enough to exclude small particles and microorganisms. The distance between the sieve and the filter would have to be large enough to allow the water to pass through both easily.

#### *Bird wires*

The upper exterior part of the collector could be surrounded by a so-called "bird wire" or "bird ring" in order to prevent droppings from birds sitting on the top of the collector entering the sample. Exceptions are plots situated in areas with a low bird density (e.g. in northern Fennoscandia). Bird rings could be necessary for both bulk and throughfall. In regions with bird dropping problems, either a bird sitting ring or a bird rejection device can be used. They should be sufficiently slim, so that they neither represent an aerodynamic blockage, nor attract birds to sit on them.

### Storage containers and tubing

The collection bottle shall be large enough to contain the largest amount of precipitation expected during the sampling period at the sampling location. In many cases 2 - 5 litre bottles are used. Thus it is possible to avoid an underestimation of most of the real precipitation quantity, which is one of the most important variables for the flux calculations.

To slow down algal growth and nitrification in samples, the sample containers should be kept cold and in the dark. The best way of achieving cold and dark conditions are keeping the sampling container in a pit hole (Figure 5) or wrapping aluminium foil around the container (although this is considerably less effective than a pit hole). Another way to achieve this is to use PVC pipes (used for wastewater tubes), in which the bottles are placed (Figure 5). Ventilation holes in the pipes are necessary since these pipes can heat up inside. The collector has to be placed in the pipe in such a way that the upper part of the collector extends by several cm (5-10 cm) above the upper part of the pipe. All parts of the sample have to be kept far from possible contamination by soil splashing from the ground.

When collectors and sample containers need to be connected black polyethylene tubes or other tubes excluding light and not interfering with the sample should be used. The length and angle of the tubes should allow rapid throughflow in order to minimise evaporation loss. On no account should there be dips in the tubes.

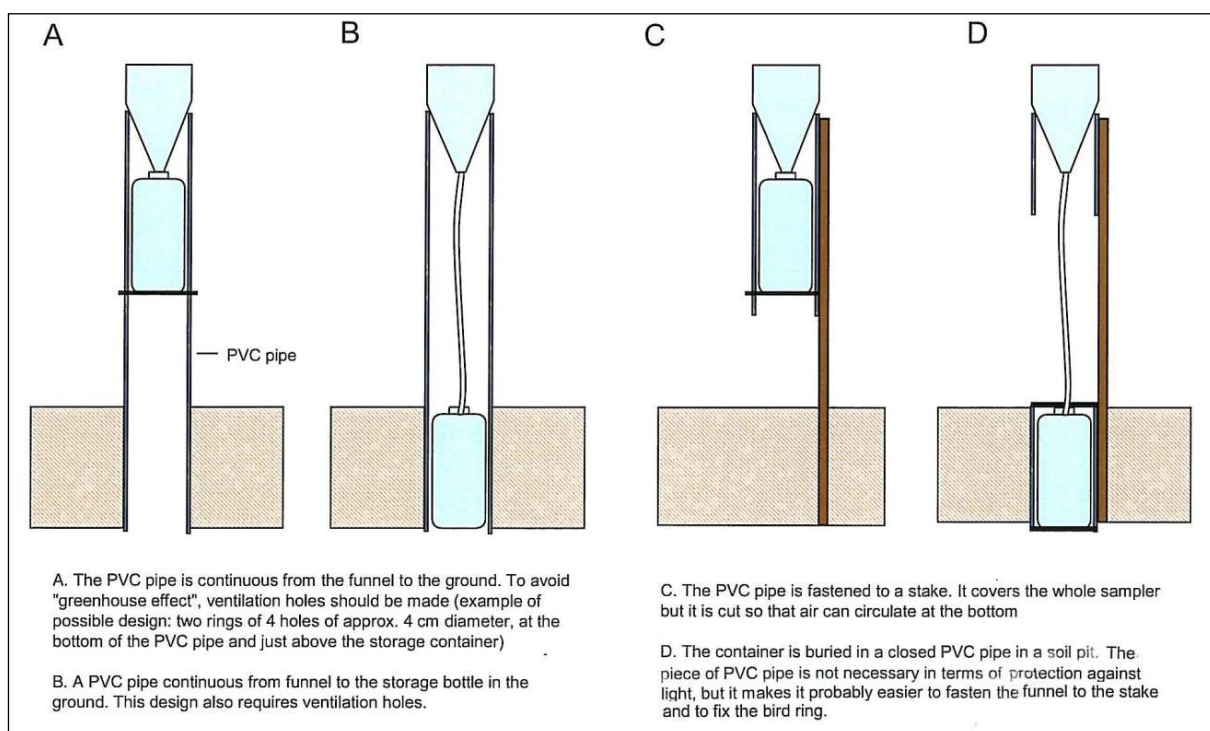

**Figure 5: Possible measures to install the deposition sampler. Method D gives the best protection against light and heat.**

#### 4.3.1.2 Bulk precipitation collectors for snow

The funnel-type bulk precipitation collectors described in 4.3.1.1. are no longer appropriate when, according to meteorological statistics or prognoses, snow is common and important. The time period for this differs of course between regions and even within regions (e.g. with altitude or distance to the coast).

Snow collection in the open field is more difficult than rain collection and more difficult in the open field compared to within the forest. Special snow collectors should be used. A minimum of three replicates is necessary. So far, however, there are no scientific studies upon which recommendations for equipment could be based. In the EMEP manual (2001), it is advised to use an open polyethylene cylinder with a diameter of 20 cm. The height of the cylinder should be at least twice the diameter in order to prevent blow-out. The snow collector should be equipped with a tight-fitting polyethylene lid, which is put on when the collector is brought indoors for the sample to melt.

According to the experiences gained in countries with long periods of snowfall, the size of the collecting surface per collector should be much larger ( $\geq 500 \text{ cm}^2$ ) in areas with heavy snowfall and in the form of a circle. In order to be able to store the snow, a disposable heavy-gauge polyethylene plastic bag of sufficient thickness ( $\geq 100 \mu\text{m}$ ) can be placed under the upper part of the collector (for example, suspended from a hoop attached to a support), which still has to fulfil the requirements defined in Section 4.3.1.1. Bags may be easier to transport than solid containers, but special care has to be taken to avoid breakage. It is important that the plastic is thick in order to minimise the risk for this. In case of frequent changes between snow and rain, both types of collectors can be run in parallel. Depending on the proportion of snow or rain, the local operator will decide from which type of collector to collect the sample for analysis.

Wet-only collectors are not recommended for collection of snow because the aerodynamic design is not suitable and because heating of the funnel to melt the snow may cause serious evaporation losses (EMEP 2001).

As is the case for rainfall collectors, all materials used should not interact with the sample solution.

Examples of rain and snow collectors are shown in the manuals for Integrated Monitoring (ICP Integrated Monitoring, 1998) and EMEP (<https://projects.nilu.no//ccc/manual/index.html>).

#### **4.3.1.3 Wet-only collectors**

Information on the contribution of dry deposition and on the differences observed between wet-only and bulk collectors can, in many cases, be obtained by the EMEP monitoring experiences in each country. Alternatively, in a pre-study, the two types of collectors should be run in parallel for at least one year at the same location.

No internationally standardised design of wet-only collectors exists. Some examples are given in the EMEP manual. There might be substantial differences from one collector to another, even with the same general design. This is a result of air turbulence, the detection of precipitation (type of resistance, heating or not, optical detector, etc.), the time delay in opening or closing the collector, the way samples are stored inside the collector, heating or not of the collecting surface in winter etc. Each country should compare its wet-only collector for at least a year with an official rain gauge, in order to know its collecting efficiency. However, the comparison between bulk and wet-only measurements should be done more systematically in each country, for some years.

The WMO manual ([https://library.wmo.int/pmb\\_ged/wmo-td\\_1251.pdf](https://library.wmo.int/pmb_ged/wmo-td_1251.pdf), WMO 2004) presents a list of criteria for a well performing wet-only collector. One crucial point is the sensitivity of the sensor. It is stated that the wet-only collector must give comparable results to an official meteorological rain gauge. Comparability is defined by WMO as: “+0% to –20% for liquid equivalent depths of 0.5 to 2.5 mm of precipitation and +0% to –10% for liquid equivalent depths >2.5 mm of precipitation”.

## 4.3.2 Equipment for throughfall monitoring

### 4.3.2.1 Throughfall collectors for precipitation other than snow

Throughfall collectors may be either funnels or gutters. The advantage of using funnels of the same type as for bulk deposition sampling is that this makes comparison between bulk deposition and throughfall easier, as effects caused by type of sampler will be minimised. Gutters have the advantage that they integrate over a larger canopy gradient than funnels (Thimonier 1998). In general, number and location of collectors is more important than sampler type (Thimonier 1988).

Among collector characteristics that can affect sample volume and/or solute concentrations are the collecting area, the shape of the collector, the material of which it is made, the height of the orifice above ground level, and the height of the vertical side wall and the width of the rim.

#### *Collecting area*

For funnels, the collecting area shall be wide enough to collect sufficiently large samples for analysis of all ions/elements of interest. In most cases a diameter of between 16 and 25 cm is suitable (giving a surface area between 200 and 500 cm<sup>2</sup>), similar to bulk precipitation collectors. In areas where the precipitation is generally low and sampling frequency is high, a larger funnel diameter is recommended. Collecting area will also affect the amount of dry deposition included in the sample. Starr et al. (2007) observed an increase in throughfall solute loads with decreased funnel size, which was interpreted as being due to increased efficiency in trapping dry deposition.

The true collecting area should be measured and documented as for bulk precipitation, and is estimated in the same way.

#### *Rim*

For information about the rim, refer to Section 4.3.1.1.

#### *Shape*

Throughfall collectors often have the same shape as collectors of bulk precipitation (Section 4.2.1). This has the advantage of being easily able to compare with bulk deposition, thus achieving compliance of canopy interaction models. Collection vessels with sloping sides must be avoided in order to prevent any loss of precipitation due to splashing (see section 4.2.1), especially during precipitation events when rain droplets impact with high energy. A vertical upper part to the funnel may result in significantly greater throughfall deposition loads, even though volumes are unaffected. This has been attributed to increased retention of dry deposition and litterfall (Starr et al. 2007).

In the case of gutters, several short gutters are preferable to one long gutter as wetting and evaporation losses are lower (Thimonier 1998).

#### *Material*

For information about material, refer to Section 4.3.1.1.

#### *Height above ground level*

The throughfall collectors should be placed with the sampling area at a height of approximately 1 m above the ground level. Otherwise, refer to Section 4.3.1.1. It is important to avoid contamination by soil splash or blown soil. Gutters, of course, must be placed at an

angle to ensure good water flow and minimise evaporation; however, the effect this has on the collecting area has to be taken into account.

#### *Sieves*

For information about sieves, refer to Section 4.3.1.1.

#### *Bird wires*

For information about bird wires, refer to Section 4.3.1.1.

#### *Storage containers and tubing*

For information about storage containers and tubing, refer to Section 4.3.1.1.

### **4.3.2.2 Throughfall snow collectors**

For information about snow collectors, refer to Section 4.3.1.1.

## **4.3.3 Equipment for stemflow monitoring**

### **4.3.3.1 Stemflow collector design**

Stemflow collectors, attached directly to the tree stems, may be either spirals or collars. The collector must be firmly attached to the bark to prevent stemflow from flowing behind it. However, it is important that the bark is not damaged as sap may then run out, contaminating the sample. The slope of the collecting surface should be more than 25° to prevent obstruction of the water flow (Bleeker et al. 2003). The width of the collecting surface is also important. If it is too wide, the risk of contamination by litter and throughfall is increased, while if the collector leans towards the bark, the water may run over. It is important that the cross-sectional area (width x depth) is large enough to prevent water overflow even during heavy storms. The collector surface should be smooth and without obstructions in order to ensure rapid flow and limit losses due to evaporation. A filter should be used to minimise sample contamination by litter, dead insects etc. However, it is important that water is able to penetrate the filter effectively in order to prevent wetting loss. Loose filters are therefore recommended. Tubes from the stemflow collector to the storage container should allow water to flow rapidly in order to minimise wetting loss. There must not be dips in the tubes and they should be dark. Storage containers should be large enough to prevent overflow in cases of large precipitation amounts. It is also important that the containers are kept cool and dark to minimise microbiological or chemical changes in the sample. As is the case for throughfall, the material of which the collector and its containers, tubes, glue etc. is made should not interact with the sample solution. However, trees grow and there is diurnal variation in the stem circumference, and these factors must be taken into consideration when choosing the material. Silicone has been recommended (ICP Integrated Monitoring 1998).

### **4.3.4 Recommendations for a harmonised collector**

Based on the above Sections, it is possible to make recommendations for a harmonised collector for throughfall and bulk deposition (Žlindra et al. 2011). The sampling equipment should consist of a funnel and a receiving vessel. The material used for the collector should be high density polyethylene. The diameter of the collecting surface should be 16 cm, the sampling area horizontal and the upper part of the collector vertical, following the design shown in Fig. 4. The surface of the collector must be smooth. The height of the sampling surface should be 1 m above ground level. An inert sieve with a mesh size of 1 mm should be placed loosely at the top of the neck of the collector. A bird ring is recommended. Sample containers should be kept cool and in the dark, preferably in pit holes if possible.

## 4.4 Sampling frequency

Ideally, the sampling period should be short, in order to minimise artefacts due to evaporation or algal growth in the sample containers. The risk of data loss due to contamination should also be considered. It is worse to lose one of relatively few long-term samples than to lose one of many short-term samples. It is recommended to use weekly sampling. If it is not possible to analyse weekly samples, for example for financial reasons, pooling of weekly samples to collective samples representing periods of up to one month is recommended. If weekly sampling is not practical, sampling may be carried out monthly or a time interval of every two or three weeks, depending mainly on climate, access to the plot and method used. The frequency of emptying the containers should be the same for all deposition measurements (throughfall, stemflow and wet/bulk deposition).

## 4.5 Sample collection, transport and storage

### 4.5.1 General procedure

Sampling, sample handling and cleaning should be carried out in the same manner for bulk/wet deposition, throughfall and stemflow monitoring. During sampling all possible contamination of samples and equipment must be avoided. It is a general precaution never to touch the surface of the equipment that comes into direct contact with the sample solution. Disposable talc-free polyethylene gloves may be used as an additional precaution. All incidents, special procedures and observations during sampling and sample handling should be recorded in the forms that accompany the samples to the laboratory and, if in use, the sampling logbook.

### 4.5.2 Before sampling

A clean collection gauge is used to collect the sample solution. The equipment should be rinsed with deionised water before sampling. Alternative methods include placing a new strong polyethylene plastic bag in the sample container for each sampling period or to replace the entire collector.

#### 4.5.2.1 Storage conditions during sampling

For information about storage conditions during sampling, refer to section 4.3.1.1.2.

#### 4.5.2.2 Prevention of algal growth and nitrification during sampling

Cool and dark storage will to a considerable extent prevent growth of algae and chemical reactions. In many cases and especially during the darker and colder season, keeping the bottle dark is sufficient. If it is impossible to obtain low temperatures in sample bottles a possible precaution during the sunny and warm season, could be to add a preservative to the sample container before sampling. A variety of chemicals can be used for this purpose. The main criterion is to use an effective, non-volatile preservative, which does not interfere with the analysis of any ion of interest (this should be checked with the laboratory and its use validated first). If interferences cannot be avoided, it may be necessary to use two parallel collectors, one with preservative and one without. Persistent chemicals such as mercury should be avoided for environmental reasons. Any use of preservatives shall be recorded in the logbook.

Nitrification is a two-step process. Bacteria known as Nitrosomonas convert ammonium to nitrite. Next, bacteria called Nitrobacter finish the conversion of nitrite to nitrate. The reactions are generally coupled and proceed rapidly to the nitrate form. These bacteria known as “nitrifiers” are strict “aerobes,” meaning they must have free dissolved oxygen to

perform their work. Nitrification occurs only under aerobic conditions at dissolved oxygen levels of 1.0 mg/L or more. A sufficient population of nitrifying bacteria must be present in order to nitrify. These bacteria are attached growth organisms, meaning that they must attach themselves to the surface of an object. It is believed that nitrifiers may attach to the sides of the container, to particles in the sample and perhaps to algae particles. Nitrification stops at a pH below 6.0. Temperatures above 10-16 °C and below 45°C promote and increase nitrification (Table 3). As the temperature increases, the nitrification rate increases to a certain degree. If nitrification is lost, it will not resume until the temperature increases to well over 10°C.



**Table 3: Temperature and nitrification (Gerardi 2002).**

Temperature	Effect upon nitrification
> 45°C	Nitrification ceases
28-32°C	Optimal temperature range
16°C	Approx. 50% of nitrification rate at 30°C
10°C	Significant reduction in rate, approx. 20% of nitrification rate at 30°C
< 5°C	Nitrification ceases

To determine the potential nitrogen transformation, the following test can be made periodically. The standard collector, unpreserved and kept dark, is run in parallel with two extra collectors located close to the standard collector. One of the extra collectors is run with preservative, while the other is unpreserved and exposed to light. All samples are analysed for nitrogen compounds, nitrate, ammonium and organic nitrogen. The difference in nitrogen concentration will indicate the degree of nitrogen transformation.

#### 4.5.2.3 Snow samples

A special problem with snow sampling is that a frozen cap of ice/rime/snow can form on top of the collector, and it is then difficult to accurately estimate how much of this cap should be included in the sample. One solution is to place a sheet of clean cardboard on top of the cap and then push sharply downwards. Thus, snow that should have fallen into the collector will be included in the sample.

#### 4.5.2.4 Collecting the samples for analysis

After each sampling period, the volume of each individual throughfall and stemflow sample must be determined. If only an aliquot of the sample is sent to the laboratory, the volume of each sample must be determined in the field. Volume can be determined by either weighing or using a measuring cylinder. If the whole sample is sent to the laboratory, the volume may be determined in the laboratory. If identifiable contamination has occurred so that it is necessary to discard a sample, the volume and reason for discarding should be recorded. The sample is decanted by means of a clean funnel into a clean measuring cylinder, taking great care to avoid spillage or contamination, or alternatively is determined gravimetrically. Each sample can then be analysed separately or be pooled together to separate collective samples (to reduce risk of contamination, each sample should be kept in two separate parts). A suitable aliquot of each sample, or of the collective sample, is transferred to a clean laboratory bottle. The funnel, measuring cylinder and laboratory bottle used should be made of chemically inert material. Polyethylene, tetrafluoroethylene or tetrafluoroethylene-fluorinated ethylpropylene polymer are recommended by EMEP (2001). Borosilicate glass may be used if properly cleaned, but some glass may contaminate the sample with alkali and alkali earth cations (EMEP 2001). Metals or materials with unknown chemical properties should be avoided. Precautions shall be taken to avoid contamination.

Extreme care should be taken if samples are collected during precipitation events, as there is then a higher likelihood for contamination of the sample during handling. If possible, sampling should be carried out during a pause in the event (WMO 2004).

If the sample in the throughfall collector is frozen or in the form of snow, the collection gauge is removed, replaced with a new collector, and the frozen collector closed with a tight cover and taken indoors to melt the snow. The same procedure and the same precautions as mentioned above are applied.

#### 4.5.2.5 Pooling of samples from the same sampling period

Pooling of samples can be carried out in either the field or the laboratory. If only part of the total sample is transported to the laboratory, this must be a representative part. All sub-

samples (i.e. all samples from individual containers) must therefore be thoroughly mixed in the field before taking an aliquot. If complete sub-samples cannot be pooled (for example, due to too large sub-sample volumes), portions of the sub-samples may be pooled instead as long as these portions are mixed in proportion to their volumes. Bulk deposition and throughfall samples are weighted according to volume estimated using either a measuring cylinder or similar container, or from the weight. Stemflow samples may be weighted either by basal area or collected volume. If stemflow samples are pooled together, they can only be pooled for trees of the same species and of similar size and dominance. Throughfall and stemflow samples must be kept separate. All details of the pooling procedure shall be recorded in the logbook.

If samples are pooled to collective samples, sub-samples that are suspected of being contaminated (e.g. because of odour or colour in the field) must not be included in the collective samples but should be analysed separately. Only if chemical analysis shows no contamination to be present in these sub-samples should the data from them be included with the data from the other sub-samples.

In the case of missing sub-samples (for example, due to contamination of one of the collectors by bird droppings), a correction can be performed for both volume and concentration of the missing sub-sample, based on correlations derived from other sampling periods (Bleeker et al. 2003). However, this may not be necessary if a large number of collectors are used and only one sub-sample is missing, as the remaining sub-samples are then likely to provide a satisfactory estimate.

### **4.5.3 Storage and transport**

#### **4.5.3.1 Transportation to the laboratory**

Each consignment of samples should be accompanied by a field form that informs the laboratory about the type and origin of the samples (e.g. plot number, collector number, sample type (throughfall, stemflow), and sampling period), specific observations that may be relevant for performing the analyses, such as suspected contamination or alteration of sampling volume etc. The measured total volume of the samples should also be noted on these forms. In some countries the total sample is transported to the laboratory in order to maintain accuracy. The volume is therefore noted on the analytical record.

The samples should be transported in special insulated boxes in order to protect the samples from light and heat and to avoid breakage of the sample containers. The use of freezer packs ("blue ice") and of a maximum/minimum thermometer in the boxes, to permit stricter control of possible degradation, is recommended.

If the transportation distance is long, it is recommended to use express post or a courier service that can guarantee delivery within 24 hours (preferably to arrive at the laboratory the following morning). Special boxes should also be used for this purpose.

#### **4.5.3.2 Storage of samples prior to pre-treatment**

The samples shall be kept in a refrigerator (0-4°C) prior to pre-treatment, as this will slow most chemical and biological sample degradation. The storage period should be kept as short as possible. This is especially important for parameters known to change upon storage, such as organic carbon. The maximum storage times for sub-samples for the individual analyses should be determined by the individual laboratories. The sub-samples should preferably not be frozen, as there is evidence in the literature to show that this can have an effect on the samples and analysis results (e.g. increased variance found by MacDonald and Laughlin 1982), although this has not always been found (e.g. Dore et al. 1996, Matilainen et al. 2002).

### 4.5.3.3 Pooling of samples from subsequent sampling periods

Weekly samples can be analysed as they are or, in order to save money, mixed to samples representing longer time periods (e.g. two weeks to one month) before analysis. If samples are mixed, they must be mixed in proportion to their volumes. However, special care must be taken in the mixing procedure. Every additional step in the sample preparation involves additional risks of contamination and errors.

## 4.6 Sampling method for the measurement of mercury deposition

Deposition of mercury differs from that of other elements because of its chemical characteristics. Mercury is liquid at ambient temperatures and can stay gaseous Hg (0) in the atmosphere. There it can be oxidized to Hg (2+) by various chemical reactions and washed out by rain water. It can change the oxidation status and also produce gaseous organometallic compounds. Therefore, it must be stabilized when collected in deposition samplers to reduce outgassing.

### 4.6.1 Sampling design

The samplers have to be arranged along the location criteria outlined in chapter 4.2. A minimum of three samplers for open field deposition and nine samplers for throughfall deposition is recommended.

### 4.6.2 Sampling equipment

Measurements of mercury lays in the range of ng/l and is therefore sensitive to contamination and adsorption on the devices used for sampling and analysis. Therefore, it is highly recommended to use only devices, components and chemicals that are known for their suitability. However, adequate testing of all materials and chemicals before use is absolutely necessary to prevent sample contamination and carryover via adsorption.

#### 4.6.2.1 Equipment for bulk deposition

Measurement of bulk mercury deposition is gathered via a specifically developed bulk deposition sampler (Figure 6). For detailed information about the sampler development, the testing and the comparison with other samplers see König et al. 2021.

The main part consists of a 1.35 m long PVC plastic tube with a bottom (diameter: 25 cm, Figure 6). In order to reduce temperature fluctuations in the sample (prevention against overheating in the summer and freezing of the samples during winter) the bottom of the tube must be installed at 50 cm depth into the ground. On the bottom of the tube a 5-L PFA-bottle filled with 100 ml HCl 1 % (for stabilizing the Hg compounds) is placed, in which the sample is collected and stored in the field and therefore needs to be reachable.

A Duran glass (borosilicate) funnel (diameter: 25 cm) is located at the top of the tube. A silicone ring is installed as an intermediate layer between the tube and the funnel. To avoid water penetration into the space in between funnel and tube, a 10 cm broad silicone rubber strap is spanned around them. Penetration of large particles, e.g., insects or litterfall is prevented by means of a filter wool (for example: Co. Vitakraft). It is placed in the funnel outlet from above. Two metal screws, to which a funnel holder can be attached (Figure 7), lift the funnel rim approximately 10 cm higher than the upper edge of the plastic pipe. They are placed at a height of 110 and 120 cm (60 and 70 cm above the soil).

A metal sheet with a height of 36 cm and two tensioning straps for closing are fixed at the height of 60 cm (10 cm above the soil). Inside the tube, 5 cm above the metal sheet, a

plexiglass plate with a drilled hole (diameter: 1.5 cm) is attached. Between the metal sheet and the sampling bottle, just below ground level, two round extruded polystyrene (XPS) plates with a slit for the Teflon tube are clamped just below the opening flap in such way that the sample chamber will be closed and insulated after twisting the two plates. A Teflon tube (diameter: 1.4 cm) is led through the holes in the plexiglass plate and XPS plates connecting the funnel with the sampling bottle (Figure 6). The Teflon tube is tightly attached to the funnel outlet by a nozzle with a screw connection. Just above the sampling bottle a plastic funnel sits upside down over the Teflon tube to avoid contamination of the sample. In addition, a parafilm piece can be strained over the plastic funnel and the bottle neck.

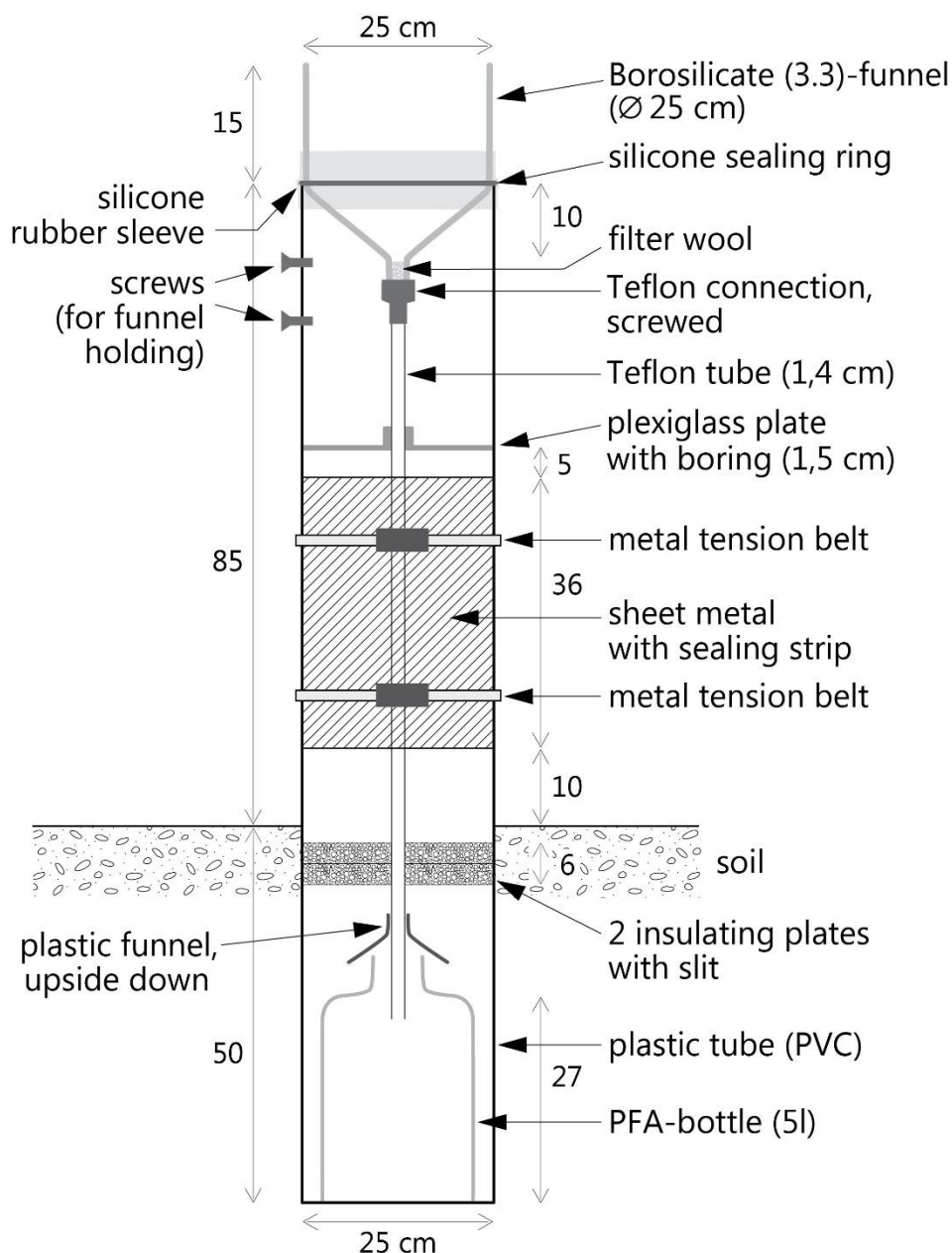

Figure 6: The developed mercury bulk deposition sampler and its dimensions in cm.

#### 4.6.2.2 Equipment for throughfall monitoring

For throughfall measurements the same samplers as for bulk deposition measurements are used. A minimum of nine samplers is advised to be placed in the plot.

### 4.6.3 Sampling frequency

Samples are collected together with the bulk samplers in the open field and at the same time as the throughfall samples for the main elements, therefore normally fortnightly.

### 4.6.4 Sample collection

For collecting, handling, and transporting samples, general precaution as described in chapter 4.5 must be considered. Any sort of contamination should be avoided. The procedure for collecting samples from the sampler is divided into several steps.

Before opening the sampler, a canvas cover is placed besides the sampler. It provides a bottom layer for the person taking the sample as well as for additional equipment required. Next, the metal sheet is removed. Afterwards, the XPS plates and the possibly used parafilm closure on the Teflon tube are removed. Then the funnel holder is fixed to the sampler and the funnel raised and clung on to the holder (Figure 7). After these preparations, the sampling bottle can be removed from the sampler and be closed with a cap.

In the next step, the borosilicate funnel and tubing are flushed with 150 ml HCl 1 % (v/v) twice to desorb possible Mercury compounds from the surface of the system and to control possible contamination. Therefore, the bottle holder together with a 250 ml PFA-bottle are placed in the sampler with the teflon tube reaching into the bottle. Afterwards, the funnel needs to be rinsed with a teflon dash bottle and 150 ml HCl 1 % (v/v). Now the bottle is removed and replaced by a second 250 ml PFA-bottle for the second funnel rinsing. Subsequently, the filter floss ball together with the adherent particles is carefully removed from the funnel outlet with a teflon tape wrapped tweezer and replaced by a new filter floss bundle. After removal of the funnel rinsing bottle and the bottle holder, a new 5-L PFA sampling bottle, filled with 100 ml HCl 1 %, is placed in the sampler. The funnel holder is removed and the funnel and teflon tube are slowly lowered such that the teflon tube reaches into the sampling bottle. Thereafter, a parafilm closure is attached above the teflon tube and the sampling bottle. In the next step, the XPS plates are inserted and twisted and the metal sheet placed before the sampler opening and guyed.

In the case that any severe contamination or damage occurred on the funnel, the teflon tube or the connection nozzle, the relevant parts are substituted by new ones.

### 4.6.5 Sample transport and storage

The sample bottles and the flushing solutions are transported to the laboratory. They can be stored at 4 °C until analysis. For longer storage it is recommended to oxidize and filter the samples before storage.

For oxidation of mercury to Hg (II), all samples are added in the original sample bottle with as much bromine chloride (BrCl) ( $c(\text{Br}_2) = 0.05 \text{ mol/l}$ ) and HCl ( $w/w = 37 \%$ ) as necessary for an end concentration in the samples of 0.5 % (v/v) for BrCl and 1 % (v/v) for HCl. (detailed description of the procedure in Annex 6). After addition of the acid and the bromine solution the sample bottles are closed and shaken by hand. Then the sample bottles rest for 1 hour before excess bromine is subsequently destroyed by a spatula tip of ascorbic acid until solution is not yellow anymore.

After the oxidation procedure the samples have to be filtered with membrane filters (0.45  $\mu\text{m}$ ).

The oxidized and filtered samples can be stored for a couple of weeks.

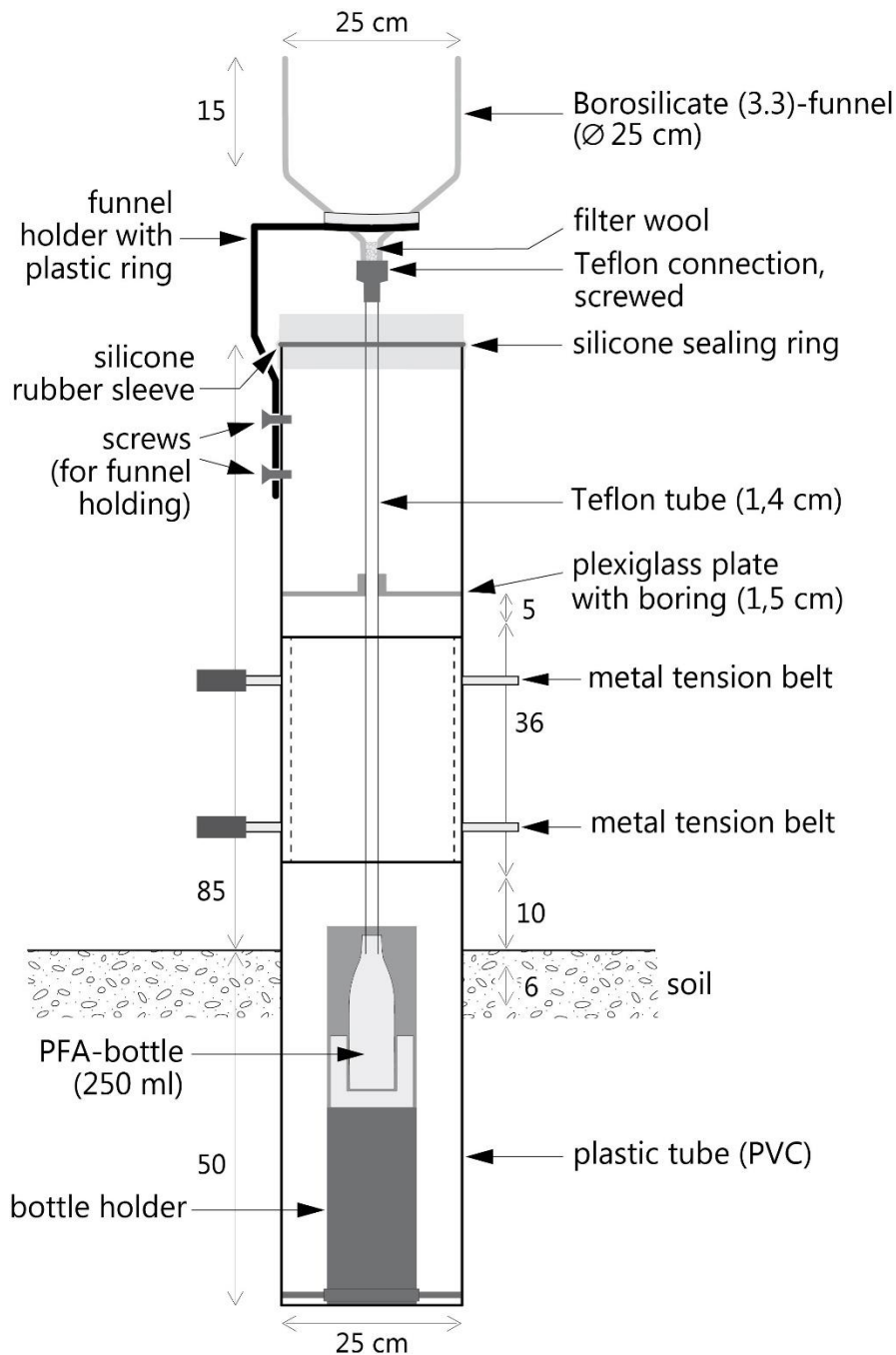

Figure 7: The developed mercury bulk deposition sampler after removing of the sample bottle and prepared for flushing.

## 5 Measurements

### 5.1 Measurements and reporting units

#### 5.1.1 Selected variables

The parameters to be determined on the samples are listed in Table 4 according to whether their determination is mandatory or optional. Mandatory parameters are those that are

considered essential for the activities of the ICP Forests Deposition Monitoring Programme, and should therefore be determined on a regular basis in all European countries. Optional parameters are those that are determined in order to meet regional or national requirements. In practice, most countries will have to determine both mandatory and optional parameters because all the cations and anions that are present in significant amounts in the samples are required for data validation purposes, e.g. for calculating ion balances.

Participating countries and laboratories are free in their selection of analytical methods as long as the analytical work is performed in accordance with the guidelines. Standardised analytical methods and procedures should be used, preferably ISO or EN/CEN methods and/or those applied in the EMEP and ICP/Integrated Monitoring programmes. Methods suitable for the analysis of bulk precipitation, throughfall, stemflow and fog are given in Table 5: detailed descriptions are given in Annex 4. Methods that are not recommended, since they tend to give poor results in laboratory inter-comparisons, are given at the end of Annex 4. The list of ISO and EN/CEN methods is given in Annex 5. The lists of possible methods are not complete, and only include the most frequently used methods. The tables also give some information about any additional pre-treatment necessary for specific analytical methods. More details can be found in the ISO and EN/CEN standards and in the EMEP manual.

**Table 4: Mandatory and optional parameters to be analysed in bulk deposition, throughfall, stemflow and fog samples.** (DOC: dissolved organic carbon,  $N_{\text{total}}$ : total nitrogen, DON: dissolved organic nitrogen)

Sample type	Mandatory	Optional	Comments
<b>Bulk deposition, throughfall, stemflow</b>	Amount of precipitation		This variable is essential for the determination of fluxes. It must be measured as accurately as possible.
	pH and conductivity at 25°C		
	Na, K, Mg, Ca, $NH_4^+$	Al, Mn, Fe, and other heavy metals, e.g. Cu, Zn, Hg, Pb, Cd, Co, Ni, Cr	
	$Cl^-$ , $NO_3^-$ , $SO_4^{2-}$	$P_{\text{total}}$ , $PO_4^{3-}$ , $NO_2^-$	To check for contamination due to bird droppings either $PO_4^{3-}$ or $P_{\text{total}}$ can be measured. To calculate organic phosphorus both parameters have to be measured $NO_2^-$ may indicate pollen-driven $NO_3^-$ reduction during spring.
	Alkalinity		Mandatory for individual samples if pH > 5
	DOC, $N_{\text{total}}$ ( $N_{\text{total}}$ is not mandatory for bulk deposition, but is highly recommended)	$S_{\text{total}}$ , $HCO_3^-$ , DON, $C_{\text{total}}$	$HCO_3^-$ can either be obtained by calculation (from pH, total alkalinity, temperature and ionic strength) or by direct measurement
<b>Fog</b>		pH, conductivity	
<b>Frozen fog (rime)</b>		Na, K, Mg, Ca, $NH_4^+$	
		$Cl^-$ , $NO_3^-$ , $NO_2^-$ , $SO_4^{2-}$ , $P_{\text{total}}$	
		Alkalinity	
		Al, Mn, Fe, and other heavy metals, e.g. Cu, Zn, Hg, Pb, Cd, Co, Ni, Cr	

**Table 5: Analytical procedures recommended for the analysis of bulk precipitation, throughfall, stemflow and fog samples. For further details, see Annex 4.**

Parameter	Method/Instrument	Additional pre-treatment required	Comments
pH	Potentiometry		Determined in the laboratory. Two-point calibration must be used.
Conductivity	Conductimetry at 25°C		Conductivity measurements made in the field can help to give a rough estimate of the quality of the sample and to reject contaminated samples.
Total alkalinity	Titrimetric determination (Gran, two end-point, titration to pH 4.5 with correction for extra acid)		Mandatory for all samples with pH > 5. One end-point titration without correction should <u>not</u> be used
Sulphate	<ul style="list-style-type: none"> <li>• Ion chromatography (IC)</li> <li>• Spectrophotometry, e.g. the Thorin method or Methyl-thymol-blue method (CFA)</li> <li>• Potentiometric determination</li> <li>• ICP/OES (<math>S_{\text{total}}</math> for bulk deposition)</li> </ul>		IC is the recommended method. The use of ICP for stemflow and throughfall samples requires correction for organic S at high DOC concentrations. Spectrophotometric methods should not be used for coloured samples without correction.
Nitrate	<ul style="list-style-type: none"> <li>• Ion chromatography (IC)</li> <li>• Spectrophotometry, e.g. azo dye after reduction to nitrite (CFA)</li> </ul>		IC is the recommended method.
Nitrite	<ul style="list-style-type: none"> <li>• Ion chromatography (IC)</li> <li>• Spectrophotometry, e.g. azo dye after reduction to nitrite (CFA)</li> </ul>		IC is the recommended method.
Chloride	<ul style="list-style-type: none"> <li>• Ion chromatography (IC)</li> <li>• Potentiometric detection (CFA, FIA)</li> <li>• Spectrophotometry, e.g. Hg-thiocyanate method (CFA)</li> </ul>		IC is the recommended method.
Phosphate	<ul style="list-style-type: none"> <li>• Ion chromatography (IC)</li> <li>• Spectrophotometry</li> </ul>		IC is the recommended method.
Total phosphorus ( $P_{\text{total}}$ )	<ul style="list-style-type: none"> <li>• Spectrophotometry, molybdenum blue method</li> <li>• ICP/OES</li> </ul>		Ion chromatography is not recommended due to the high limit of quantification. Spectrophotometry: $P_{\text{total}}$ is determined as $\text{PO}_4^{3-}$ after digestion with strong oxidising agents.
Organic phosphorus	$P_{\text{total}}$ analysis, and $\text{PO}_4^{3-}$ -P analysis		Organic P = $P_{\text{total}} - \text{PO}_4^{3-}$ -P



Parameter	Method/Instrument	Additional pre-treatment required	Comments
Ammonium	<ul style="list-style-type: none"> <li>Spectrophotometry, e.g. indophenol method (CFA) or ammonia diffusion cell method (FIA)</li> <li>Ion chromatography (IC)</li> </ul>		<p>IC: high Na concentrations may interfere with the analysis; the limit of quantification is also often too high</p> <p>FIA: filtration and dialysis of the samples is necessary: however, automated FIA systems include this.</p>
Na, K, Mg, Ca	<ul style="list-style-type: none"> <li>AAS Flame</li> <li>AES Flame (only for Na and K)</li> <li>ICP/OES</li> <li>Ion chromatography (IC)</li> </ul>		<i>Note!</i> Differing results are possible depending on the methods used: IC determines ions, AAS and ICP total elements
Al and heavy metals (Co, Cr, Cu, Cd, Pb, Ni, Zn) (not Hg)	<ul style="list-style-type: none"> <li>AAS Graphite furnace</li> <li>ICP/MS</li> <li>ICP/OES</li> <li>ICP/OES with ultrasonic nebulizer</li> </ul>	The samples are preserved with nitric acid. Pre-concentration of samples may be necessary	Instruments with low quantification limits are necessary due to the low concentrations, Control of blanks and avoidance of contamination is important.
Hg	<ul style="list-style-type: none"> <li>Cold vapour atomic fluorescence spectroscopy (CV-AFS)</li> <li>ICP-MS (special sample delivery system with Teflon components needed; the instrument must be very sensitive for Hg with low detection limit)*</li> </ul>	Oxidation to Hg (II) with BrCl, destroying of the remaining BrCl **	<p>AFS: enrichment on a gold trap possibly needed</p> <p>ICP-MS: Mercury can be measured by a mass of 202 u and 201 u. The mass 202 u is notably more sensitive and therefore more suitable for measurements in the nanogram range. However, it is disturbed by the tungsten-186 isotope <math>^{186}\text{W} + 16\text{O}</math>. Hence, tungsten must be measured simultaneously and an inter-element correction conducted</p> <p>Buyable aqueous standards:</p> <ul style="list-style-type: none"> <li>NIST 1641 d (Standard "Mercury in Water", by the National Institute of Standards and Technology) with a concentration of 1.577 mg/l</li> <li>ORMS-5 (Standard "Elevated Mercury in River Water", by the National Research Council of Canada) with a concentration of 26.2 ng/l</li> </ul>
Total nitrogen ( $N_{\text{total}}$ )	<ul style="list-style-type: none"> <li>Elementary analysis</li> <li>Spectrophotometry after oxidation to nitrate using persulphate in borate buffer solution or UV-digestion</li> <li>total N analyser with chemiluminescence detection</li> </ul>		

Parameter	Method/Instrument	Additional pre-treatment required	Comments
Dissolved org. nitrogen (DON)	Wet oxidation		Directly measured, not calculated
Dissolved org. carbon (DOC)	<ul style="list-style-type: none"> <li>• Infrared spectroscopy after oxidation to CO<sub>2</sub></li> <li>• Flame ionisation after reduction to CH<sub>4</sub></li> <li>• UV absorbance (254 nm)</li> </ul>	Use glass fibre membrane filters (not cellulose acetate/nitrate)	UV absorbance is not the optimal method and should only be used by laboratories without TOC analyser

\* For details on Hg measurement with AFS and ICP-MS and method comparison see König et al. 2021

\*\* For details see Annex 6

### 5.1.2 Analysis

In order to reach an acceptable level of analytical quality according to ISO and EN norms, a substantial effort is needed, especially during the first 1-3 years of monitoring activity, depending especially on the current quality level of each laboratory. The following Sections should be seen as a guide to the ICP Forests laboratories in their analytical work.

### 5.1.3 Reception at the laboratory, initial checks and temporary storage

Upon reception of the samples at the laboratory, the delivery should be checked immediately, and discrepancies noted, for the following:

- the accompanying forms are included in the delivery
- the number of sample bottles corresponds to that stated on the accompanying forms
- the bottles are properly closed and no leakage has occurred
- damage to the box or bottles
- presence of visible contamination
- initial pH and conductivity check for indications of contamination
- registration in the laboratory sample book and running numbers assigned

The samples (wet-only and bulk deposition, throughfall or stemflow) should be stored (protected from light at max. +4°C) in such a manner that there will be no changes in the chemical parameters to be determined before the samples are analysed (any changes in concentration should be smaller than the precision of the analyses). If sub-samples are taken for pH and conductivity measurements prior to pre-treatment, then these sub-samples should be stored in the same way.

The samples should be pre-treated and analysed as soon as possible. Excessively long storage times should be avoided in order to prevent chemical changes caused by microbial activity in the samples.

It is recommended that all nitrogen compounds (nitrate, ammonium and total nitrogen) are analysed on the same day or within the same week in order to avoid nitrification and be able to trust the nitrogen budget.

### 5.1.4 Pre-treatment of the samples

A separate sub-sample should be taken, prior to filtration, for the determination of pH and conductivity (as stated in ISO 10523 and ISO 7888). However, this is done only if the volume of the sample is sufficient for the other chemical analyses. This sub-sample should not be used for any of the other analyses. Many types of pH electrode release  $K^+$  into the sample and therefore a separate aliquot of the sample should be used to avoid contamination. Similarly, if electrical conductivity is measured on the same aliquot of sample, then this should be done before pH measurement.

The sample should be filtered through a 0.45  $\mu\text{m}$  membrane or syringe filter in order to remove any solid material and to stabilise the sample for the subsequent analyses. Filtration considerably decreases the possibility of microbially-induced changes (e.g. nitrogen transformations) in the samples as it removes all micro-organisms (except viruses). Thus, the stability and lifetime of the samples are increased. The membrane filter used should be tested beforehand in order to ensure that there is no release of soluble or particulate, carbon-containing material/compounds from the membrane. Filter paper should not be used owing to possible contamination by  $\text{NH}_4^+$  and carbon. Many types of membranes release small amounts of particulate material (containing carbon) when first used, and this will affect the DOC determination. However, this problem can be avoided by “rinsing” the membrane in the membrane holder with a known volume of pure water or (preferably) sample prior to filtration of the sample proper. Each laboratory should determine the minimum amount of rinsing water required. Tests on a number of membrane types have shown that ca. 50 ml is sufficient. Note that certain analysers may contain an internal filter to protect the device from damage by large particles, which could have a smaller pore size (e.g. 0.2  $\mu\text{m}$ ).

After filtration, sub-samples should be taken to be used for the determination of metals by e.g. AAS or ICP techniques. These sub-samples should be acidified, e.g. with suprapure 65%  $\text{HNO}_3$  to  $\text{pH} < 2$  in order to avoid the absorption of metal cations on the inside surface of plastic bottles (if used), as well as possible changes caused by microbial activity. The preserved samples can be stored for several weeks prior to analysis by AAS, ICP etc.

Another subsample should be stored at  $+4^\circ\text{C}$  and analysed as soon as possible for all other parameters.

The use of preservatives in the laboratory (chloroform, formaldehyde, mercury compounds, iodine etc.) is not recommended owing to occupational health hazards, the danger of damaging laboratory equipment (e.g. ion chromatograph columns), and possible interference in certain analyses.

## 5.2 Quality Assurance (QA) and Quality Control (QC)

The general demand for higher quality assurance is growing, and it is of high importance that the participating organizations maintain a definable and acceptable level, in both field sampling and laboratory analysis. This level should allow the production of data on a European level with known analytical errors and ranges, as this will also be the case for field methods. Thus, the data can be transmitted to any user with error ranges allowing a more optimal use for all types of calculations on a European level.

### 5.2.1 QA in the field

Before any choice is made of deposition field collectors and their distribution over the plot, a detailed study should be made of spatial variability to find the optimal sampling methodology for all types of precipitation in order to achieve representativity. A national reference manual

or standard operating procedures should be prepared, in which each step in the monitoring procedure is strictly defined and given to the personnel in connection with training in the field. Every step of the work, including special precautions needed to avoid contamination during sampling and cleaning procedures, should be well documented. A system of field blank samples and spiked samples should be employed at regular intervals in order to check the cleaning of collectors and possible sample contamination or degradation in the field and during transportation. This would be optimal, even though in practice it is very difficult to do it on a routine basis.

A supply of spare parts should be kept in store so that broken, stolen or vandalised parts of the sampling equipment can be rapidly (within one week) replaced. Smaller spare parts should accompany the standard sampling equipment so they can be replaced immediately if needed.

Communication between the field personnel and central project manager should be regular. All the operations and specific incidents or observations at the plot should be noted in the sampling logbook. Regular visits should be made to the sampling plots and the sampling procedures checked by the project manager at least once a year.

One of the most important sources of error in deposition sampling is the procedure of snow sampling, leading to a systematic underestimation of precipitation. Unfortunately, there are no specific hints to improve the sampling of snow: efforts should be made in this field.

## 5.2.2 QA in the laboratory

See Part XVI: Quality Assurance for Laboratories

### 5.2.2.1 Plausibility limits

Plausibility limits for deposition samples are given in Table 6. The values are the same as those used in the conformity tests for data submission. If the values lie outside those given below, a warning is given by the programme.

**Table 6: Range tests for deposition samples.**

FIELD	UNIT	MIN	MAX	ERROR
<i>Mandatory parameters</i>				
alkalinity	µeq/L	-50	10000	w
Ca	mg/L	0.001	275	w
Ca	mg/L	0.0001	100000	e
Cl <sup>-</sup>	mg/L	0.002	800	w
Cl <sup>-</sup>	mg/L	0.0001	100000	e
conductivity	µS/cm	1	10000	w
DOC	mg/L	0.001	100	w
DOC	mg/L	0.0001	1000	e
K	mg/L	0.002	250	w
K	mg/L	0.001	10000	e
Mg	mg/L	0.0025	100	w
Mg	mg/L	0.0001	100000	e
Na	mg/L	0.003	500	w
Na	mg/L	0.0001	100000	e
N_NH <sub>4</sub> <sup>+</sup>	mg N/L	0.002	175	w
N_NH <sub>4</sub> <sup>+</sup>	mg N/L	0.001	100000	e
N_NO <sub>3</sub> <sup>-</sup>	mg N/L	0.002	175	w

<b>N_NO<sub>3</sub><sup>-</sup></b>	mg N/L	0.0001	100000	e
<b>N_total</b>	mg N/L	0.03	350	w
<b>N_total</b>	mg N/L	0.0001	100000	e
<b>period</b>		1	53	w
<b>pH</b>		2.5	9.4	w
<b>pH</b>		1	14	e
<b>S_SO<sub>4</sub><sup>2-</sup></b>	mg S/L	0.01	500	w
<b>S_SO<sub>4</sub><sup>2-</sup></b>	mg S/L	0.0001	100000	e
<i>Optional parameters</i>				
<b>Al</b>	mg/L	0.001	8	w
<b>Al</b>	mg/L	0	10	e
<b>Cd</b>	µg/L	0.008	100	w
<b>Cd</b>	µg/L	0.0001	10000	e
<b>Co</b>	µg/L	0.008	100	w
<b>Co</b>	µg/L	0.0001	10000	e
<b>Cr</b>	µg/L	0.008	100	w
<b>Cr</b>	µg/L	0.0001	10000	e
<b>C_total</b>	mg/L	0.03	500	w
<b>C_total</b>	mg/L	0.0001	10000	e
<b>Cu</b>	µg/L	0.06	850	w
<b>Cu</b>	µg/L	0.0001	10000	e
<b>DON</b>	mg/L	0.001	100	w
<b>DON</b>	mg/L	0.0001	1000	e
<b>Fe</b>	mg/L	0	25	w
<b>Fe</b>	mg/L	0	100	e
<b>HCO<sub>3</sub><sup>-</sup></b>	mg/L	0	500	w
<b>HCO<sub>3</sub><sup>-</sup></b>	mg/L	0	10000	e
<b>Hg</b>	µg/L	0.02	100	w
<b>Hg</b>	µg/L	0.0000001	1000	e
<b>Mn</b>	mg/L	0	15.5	w
<b>Mn</b>	mg/L	0	100	e
<b>N_NO<sub>2</sub><sup>-</sup></b>	mg N/L	0.002	175	w
<b>N_NO<sub>2</sub><sup>-</sup></b>	mg N/L	0.0001	100000	e
<b>Ni</b>	µg/L	0.008	100	w
<b>Ni</b>	µg/L	0.0001	10000	e
<b>Pb</b>	µg/L	0.012	200	w
<b>Pb</b>	µg/L	0.0001	10000	e
<b>P_PO<sub>4</sub><sup>3-</sup></b>	mg P/L	0.0017	1000	w
<b>P_PO<sub>4</sub><sup>3-</sup></b>	mg P/L	0.0001	10000	e
<b>P_total</b>	mg/L	0.0017	1000	w
<b>P_total</b>	mg/L	0.0001	10000	e
<b>S_total</b>	mg/L	0.17	500	w
<b>S_total</b>	mg/L	0.0001	10000	e
<b>Zn</b>	µg/L	0.005	4500	w
<b>Zn</b>	µg/L	0.0001	10000	e

### 5.2.2.2 Data completeness

Table 4 outlines for all the physical and chemical deposition parameters whether and under which conditions they are mandatory or optional to report. When a country/federal state decides to report optional parameters, they should also fulfil the data quality requirements.

### 5.2.2.3 Data quality objectives or tolerable limits

See Table 1 and Part XVI: Quality Assurance for Laboratories, Section 3.4.1.2.1.

All reported values should have been measured according to the methods described in Annex 4.

### 5.2.2.4 Data quality limits

The laboratory results are considered of sufficient quality when the laboratory received a qualification for the concerning parameter(s) after participation in the Interlaboratory Comparisons (see Part XVI: Quality Assurance for Laboratories, Section 3.4.1.2.1).

## 6 Data handling

### 6.1 Data submission

#### 6.1.1 Procedures and forms

Forms for data submission and explanatory items are found on the ICP Forests web page, at <https://icp-forests.org/documentation/>. The quality information from the labs has to be sent together with the PLD and DEM forms to the data centre using the submission form "XX2008DP.LQA".

#### 6.1.2 Submission of data from pooled sampling periods and periods without any sample quantity

For data submission of pooled sampling periods the quantity of each single period must be submitted. The ion concentrations have to be submitted for all periods of the pooled analysed sample with the same concentrations. Only if a parameter was not analysed a blank space has to be used for submission of its concentration. A "0" (zero) has to be submitted only for sample quantity, if no sample could be taken due to no precipitation in the sampling period. An example for mandatory deposition data submission with DEM is given in Table 7.

**Table XIV-7: An example for mandatory deposition data submission with DEM.** Samples from 270109 to 090209 were pooled, no precipitation in period# 1 and 4; Potassium (K) was below quantification limit in period 6.

Seq.	Plot	Start date	End date	Period#	Sampler	Sampler_ID	Sample_ID	V_sampling	Quantity	pH	Cond.	K
....												
31	21	301208	050109	1	2	1	1	1	0			
32	21	060109	120109	2	2	1	1	1	10	4.7	148	2.1
33	21	130109	190109	3	2	1	1	1	34	4.7	148	2.1
34	21	200109	260109	4	2	1	1	1	0			
35	21	270109	020209	5	2	1	1	9	3			
36	21	030209	090209	6	2	1	1	1	53	5.1	110	-1
....												

## 6.2 Data validation

Data checks should be done as soon as results from the analyses are available. Data validation and QA should be applied in accordance with the guidelines for QA/QC procedures in the laboratory that are given in Part XVI: Quality Assurance for Laboratories before submitting it. For the validation, data should be scrutinised with regard to ion balances, conductivity, presence of extreme values, and any discrepancies in the covariation between parameters and between stations. All discrepancies noted and corrected must be documented and must accompany the results to the data storage. Excel files for analytical data validation, definition of a laboratory's methods including QA/QC procedures, and a control chart can be downloaded from the ICP Forests web page (<http://icp-forests.net/page/working-group-on-quality> and [https://www.icp-forests.org/pdf/manual/2016/ICP\\_Manual\\_2016\\_01\\_part16.pdf](https://www.icp-forests.org/pdf/manual/2016/ICP_Manual_2016_01_part16.pdf)).

### 6.2.1 Guidelines for the treatment of missing values

In the validated data set, gaps due to missing values have to be filled in order to estimate the yearly mean concentration and yearly deposition. Not more than 4 weekly or one monthly value per year should be missing in order to calculate a sufficiently reliable yearly mean concentration.

If data are missing ( $\leq 4$  weekly values and one monthly value), use the yearly mean concentration in the sample solution based on the available data to interpolate missing data. The yearly deposition is estimated by multiplying the yearly mean concentration with the annual sample volume. A separate measurement of precipitation amount is valuable when wet deposition, throughfall or stemflow samples are missing. Some conclusions may be drawn as to the missing volume for one period in relation to the total annual volume. If there are large seasonal variations in pollution concentrations, a more "true" annual mean may be obtained if the weekly or monthly value missing is interpolated with consideration to season. In this interpolation, the seasonal variation of results from a near-by plot and its normal covariation with the plot of interest is used.

## 6.3 Transmission to co-ordinating centres

All validated data of year X should be submitted yearly to the European central data storage facility at the ICP Forests Programme Coordinating Centre via the data submission website ([https://www.icp-forests.org/data/fm\\_start.php](https://www.icp-forests.org/data/fm_start.php)) before February the 15<sup>th</sup> of the year X+2.

## 6.4 Data processing guidelines

Simple guidelines for calculations are given in Annex 3. All concentration means should be volume weighted. The precipitation amount obtained by the sampling collector is used to calculate the deposition at the site. It is recommended to compare with the results from the meteorological standard gauge. If the difference is significant, the selection of collector must be reconsidered. Guidelines for interpretation of throughfall data are given in Annex 6.

The aim is to determine the total atmospheric deposition to forests as one of the major external driving forces of ecosystem development. We therefore have to distinguish between internal and external fluxes of elements, as the canopy may strongly interact with gases, particles or water passing through. This effect is known as canopy exchange and accounted for by using so-called canopy budget models (Annex 1). These allow estimation of whether the leaves and twigs act as a source or a sink for the element under consideration. In order to apply such models for deposition a feasible and cost-efficient way is to measure bulk deposition in the open field (reference value without influence of plant surfaces) and beneath

the canopy as throughfall, stemflow (for beech only) and litterfall (especially for heavy metals).

It is recommended that all countries carry out canopy budget modelling and other methods of deposition estimates and report via submitted reports on national data evaluation. In this way, countries are responsible for delivering atmospheric deposition estimates and not only throughfall, stemflow and precipitation fluxes, which can be regarded as input data to the deposition estimate. Moreover, canopy budgets will give insight in the quality of results. Only high-quality measurements give reliable estimates.

## 6.5 Data reporting

Data should be accompanied by a “Data accompanying report – questionnaire” (DAR-Q) and any other information requested by the European central data storage facility. The DAR-Q should include all details on sampling and analytical procedures. In addition, irregularities in sampling and analytical procedure, missing data, estimated yearly deposition and encountered errors in the validation, should be documented. The preparation of a national annual report on data during the year is recommended. A comparison with other national results as regards deposition to forests is recommended as a further step in the validation of the results. The document shall contain the results obtained and the interpretation of results.

All details on how data are treated and how the calculations are made shall be documented and accompany the result to the data storage. If values are below the quantification limit (not the detection limit), a value of -1 should be reported. Definitions of the quantification and detection limits can be found in Section 3.2 of the Manual Part XVI on Quality Assurance and Control in Laboratories.

## 6.6 Use of bulk open field and throughfall deposition data in reports

Reporting of ICP Forests measurements of atmospheric deposition (e.g. in ICP Forests Technical Report and similar reports) typically includes ‘current’ annual bulk open field and throughfall deposition as well as trends over longer periods (e.g. 10 years).

Aggregation of sampling period values to annual values is typically done by either calculation of volume weighted annual concentration averages, or by calculation of annual fluxes by summing up the products of concentration and quantity determined for each sampling period.

Hereafter adequate completeness criteria for the sampling (e.g. 330 days per year) and for the availability of the displayed parameter (e.g. 300 days per year) can be applied to select the plots with sufficient coverage for which annual values are displayed or included in further analyses. In addition, data quality criteria, such as a rate of passing tests defined in the ‘QA/QC in Labs’ Manual (e.g. a rate of >30% of the samples - including complete and not complete analyses - per year passing the conductivity test), can be used to flag the values displayed, e.g. in maps. Plots with too short time series can be displayed as void points on the maps. The applied completeness and quality criteria are then described in the report.



## 7 References

- A.P.H.A, AWWA, WEF, 1998. Standard methods for the examination of water and wastewater. 20th ed. American Public Health Association, Washington.
- Bartels U, 1988. Abschätzung der organischen Kohlenstoffeinträge in Waldökosysteme durch Messung der UV-Absorption (254 nm) im Niederschlagswasser. *Z. Pflanzenernähr. Bodenk.* 151: 405-406. <https://doi.org/10.1002/jpln.19881510611>
- Bleeker A, Draaijers GPJ, van der Veen D, Erisman JW, Möls H, Fonteijn P, Geusebroek M, 2003. Field inter-comparison of throughfall, stemflow and precipitation measurements performed within the framework of the Pan European Intensive Monitoring program of EU/ICP Forest. *Environ. Pollut.* 125: 123-138. [https://doi.org/10.1016/s0269-7491\(03\)00142-8](https://doi.org/10.1016/s0269-7491(03)00142-8)
- Brandstetter A, Sletten RS, Mentler A, Wenzel WW, 1996. Estimating dissolved organic carbon in natural waters by UV absorbance (254 nm). *Z. Pflanzenernähr. Bodenk.* 159: 605-607. <https://doi.org/10.1002/jpln.1996.3581590612>
- Dore JE, Houlihan T, Hebel DV, Tien G, Tupas L, Karl DM, 1996. Freezing as a method of sample preservation for the analysis of dissolved inorganic nutrients in seawater. *Mar. Chem.* 53: 173-185. [https://doi.org/10.1016/0304-4203\(96\)00004-7](https://doi.org/10.1016/0304-4203(96)00004-7)
- Draaijers GPJ, Erisman JW, Lövblad G, Spranger T, Vel E, 1998. Quality and uncertainty aspects of forest deposition estimation using throughfall, stemflow and precipitation measurements. TNO-MEP-R 98/093.
- Ellison SLR, Williams A (Eds.), 2012. Eurachem/CITAC guide: Quantifying Uncertainty in Analytical Measurement, Third edition, ISBN 978-0-948926-30-3. Available from [www.eurachem.org](http://www.eurachem.org).
- EMEP, 2001. Manual for Sampling and Chemical Analysis. EMEP/CCC Report 1/95, Revision 2001, Norwegian Institute for Air Research, Kjeller, Lillestrøm, Norway.
- Ferretti M, Chiarucci A, 2003. Design concepts adopted in long-term forest monitoring programs in Europe - Problems for the future? *Sci Total Environ* 310: 171-178. [https://doi.org/10.1016/S0048-9697\(02\)00637-X](https://doi.org/10.1016/S0048-9697(02)00637-X)
- Gerardi MH, 2002. Nitrification and denitrification in the activated sludge process. John Wiley and Sons, Inc., New York. ISBN 0-471-06508-0. <https://doi.org/10.1002/0471216682>
- Gran G, 1952. Determination of the equivalence point in potentiometric titration II. *Analyst* 77: 661-671. <https://doi.org/10.1039/AN9527700661>
- Grossi G, Lendvai A, Peretti G, Ranzi R, 2017. Snow Precipitation Measured by Gauges: Systematic Error Estimation and Data Series Correction in the Central Italian Alps. *Water* 9, 461. <https://doi.org/10.3390/w9070461>
- Houston TJ, Durrant DW, Benham SE, 2002. Sampling in a variable environment: selection of representative positions of throughfall collectors for volume and chemistry under three species in the UK. *Forest Ecology and Management*, 158: 1-8. [https://doi.org/10.1016/S0378-1127\(00\)00670-8](https://doi.org/10.1016/S0378-1127(00)00670-8)
- ICP Integrated Monitoring, 1998. Manual for Integrated Monitoring. ICP IM Programme Centre, Finnish Environment Institute, Helsinki, Finland.
- König N, Kringinger M, Schad T, Sanders TGM, Gepper F, Holzhausen M, 2021. Entwicklung und Test von Methoden zur Messung der nassen Quecksilberdeposition unter dem Kronendach von Wäldern. Texte 00/2021 Umweltbundesamt. <https://www.umweltbundesamt.de/publikationen/entwicklung-test-von-methoden-zur-messung-der>
- Kramer JR, Andren AW, Smith RA, Johnson AH, Alexander RB, Oelbert G, 1986. Streams and lakes. In: Acid deposition: long term trends. National Academic Press. Washington D.C.: 231-299.
- MacDonald RW, McLaughlin FA, 1982. The effect of storage by freezing on dissolved inorganic phosphate, nitrate and reactive silicate for samples from coastal and estuarine waters. *Water Res.* 16: 95-104. [https://doi.org/10.1016/0043-1354\(82\)90058-6](https://doi.org/10.1016/0043-1354(82)90058-6)

- Marchetto A, Mosello R, Tartari G, Derome J, Derome K, Sorsa P, König N, Clarke N, Ulrich E, Kowalska A, 2006. Atmospheric deposition and soil solution Working Ring Test 2005. ONF, Fontainebleau, France. <https://www.icp-forests.org/DocsQualLab/WRT2005.pdf>
- Matilainen A, Lindqvist N, Korhonen S, Tuhkanen T, 2002. Removal of NOM in the different stages of the water treatment process. *Environ. Internat.* 28: 457-465. [https://doi.org/10.1016/s0160-4120\(02\)00071-5](https://doi.org/10.1016/s0160-4120(02)00071-5)
- Mosello R, Derome J, Derome K, Ulrich E, Dahlin T, Marchetto A, Tartari G, 2002. Atmospheric deposition and soil solution Working Ring Test 2002. E.U. Technical Report, Fontainebleau, France, 69 pp. <https://www.icp-forests.org/DocsQualLab/WRT2002.pdf>
- Sevruk B, Hertig J-A, Tettamanti R, 1994. The effect of orifice rim thickness on the wind speed above precipitation gauges. *Atmos. Environ.* 28: 1939-1944. [https://doi.org/10.1016/1352-2310\(94\)90334-4](https://doi.org/10.1016/1352-2310(94)90334-4)
- Starr M, Ukonmaanaho L, Sibley PK, Hazlett PW, Gordon AM, 2007. Deposition in boreal forests in relation to type, size, number and placement of collectors. *Environ. Monit. Assess.* 125: 123-136. <https://doi.org/10.1007/s10661-006-9245-2>
- Stumm W., Morgan J.J.. 1981. *Aquatic chemistry*. Wiley and Sons, New York. 780 pp.
- Thimonier A, 1998. Measurement of atmospheric deposition under forest canopies: some recommendations for equipment and sampling design. *Environ. Monit. Assess.* 53: 353-387. <https://doi.org/10.1023/A:1005853429853>
- Westcott CC, 1978. *pH measurements*. Academic Press, New York. 184 pp. ISBN 9780323160605
- WMO, 1990. *Guide des instruments et des méthodes observations météorologiques (WMO- No. 8)*, 5th edition (French translation). ISBN 92-63-25008-9.
- WMO, 2004. *Manual for the GAW precipitation chemistry programme. Guidelines, data quality objectives and standard operating procedures (WMO TD No. 1251)*, GAW Report No. 160. [https://library.wmo.int/doc\\_num.php?explnum\\_id=9287](https://library.wmo.int/doc_num.php?explnum_id=9287)
- WMO, 2008. *Guide to Instruments and Methods of Observation (WMO-No. 8)*, 7th edition.
- Žlindra D, Eler K, Clarke N, Simončič P, 2011. Towards harmonization of forest deposition collectors - case study of comparing collector designs. *iForest - Biogeosciences and Forestry* 4: 218-225. <https://doi.org/10.3832/ifor0586-004>

## 8 Annex

### Annex 1: Canopy Budget Models

Applicable for use within the Intensive Monitoring Program (Geert P.J. Draaijers).

#### Introduction

The major aim of the Intensive Monitoring Program is to gain a better insight in the impacts of air pollution (specifically the elevated deposition levels of SO<sub>x</sub>, NO<sub>y</sub> and NH<sub>x</sub>) on forest ecosystems. To achieve this aim among others, relationships have to be derived between deposition amounts and effect parameters. For optimal assessment and interpretation of these relationships, deposition estimates should be as accurate as possible. Within the Intensive Monitoring Program, atmospheric deposition is estimated from results of throughfall, stemflow and precipitation measurements in combination with canopy budget models to estimate canopy exchange. In this way atmospheric deposition of sulphur, sodium, and chloride can be estimated reasonably well. Unfortunately, up to now relatively large uncertainties are involved with the estimation of canopy leaching of potassium, calcium and magnesium and canopy uptake of oxidised and reduced nitrogen using canopy budget models. Considering the major aim of the Intensive Monitoring Program, the Expert Panel on Deposition recommended to perform additional research to improve these estimates (Lövblad, 1996).

In this paper first the theory of canopy exchange is given (A1.1) followed by an overview of available models to estimate canopy exchange and evaluation of the models with respect to applicability for use within the Intensive Monitoring Program (A1.2). A1.3 presents recommendations for future activities to improve canopy exchange estimates within the Intensive Monitoring Program.

#### A1.1 Canopy exchange processes

Throughfall fluxes are found to be influenced by passive diffusion and ion exchange between the surface water and the underlying apoplast of canopy tissues. Passive diffusion is found to be the major cause of elevated anionic concentrations in throughfall while both diffusion and ion exchange contribute to cationic concentrations in throughfall (Schaefer & Reiners, 1990). The rate of canopy exchange depends on tree species and ecological setting. For example, during the growing season deciduous tree species tend to lose more nutrients from the crown foliage through leaching than coniferous tree species. Conifers, however, stay green all the year round and continue to lose nutrients throughout the dormant season (Smith, 1981). The age distribution of leaves and soil nutrient status also affects the magnitude of leaching to a large extent. Young immature leaves/needles tend to lose much more nutrients compared to older ones (except when they are hydrophobic; Parker, 1990), and fertilization is found to enhance canopy leaching considerably (Matzner et al., 1983). Biotic stresses like insect plagues may initiate large canopy leaching. Bobbink et al. (1990) monitored throughfall in heather vegetation and observed a marked increase of canopy losses occurring simultaneously with an outbreak of a heather-beetle plague. Furthermore, abiotic stresses like drought and temperature extremes are found to enhance canopy leaching (Tukey & Morgan, 1963). The presence of certain pollutants may also be of importance. Large concentrations of ozone, for example, were found to enhance the permeability of cell membranes in canopy foliage, thereby increasing ion leakage (Evans & Ting, 1973). Moreover, the amount and timing of precipitation is found to be relevant with respect to canopy leaching. Relatively long residence times during drizzle account for relatively high leaching rates compared to short rain periods with large rainfall intensities. Large rain amounts may deplete leachable pools within the canopy, thereby inhibiting ion leaching (Lovett & Lindberg, 1984). Losses from

leachable pools within the canopy are believed to be replenished within 3-4 days after a large storm by increased root uptake or translocation from other parts of the tree (Parker, 1983).

### Sulphur compounds

SO<sub>2</sub> may be taken up by the stomata. If a significant part of the SO<sub>2</sub> is retained in the foliage and translocated from the canopy to the roots, this would result in an underestimate of sulphur deposition by measuring throughfall. Gay & Murphy (1989) found that up to 70% of the SO<sub>2</sub> absorbed by foliage during short-term experimental exposures could not subsequently be removed by washing. However, Schaefer & Reiners (1990) and Granat & Hällgren (1992) conclude that essentially all of the dry deposited sulphur dioxide is eventually extracted out of the apoplast pools (i.e. aqueous layer on the outside of cell membranes) by rain and appears in throughfall.

Fowler & Cape (1983) and Cape et al. (1987) compared net throughfall measurements in a Scots pine stand with estimates of SO<sub>2</sub> dry deposition using eddy correlation techniques. For a 71-day spring period, SO<sub>2</sub> dry deposition appeared to be equal to the net throughfall flux of sulphate. For an 84-day autumn period, SO<sub>2</sub> deposition only accounted for 8% of the sulphur flux in net throughfall. The latter observation led Fowler & Cape (1983) to the conclusion that canopy leaching is a major component of the net enrichment in throughfall. According to Ivens (1990), this large difference between both estimates in the autumn period can also be explained by the omission of dry particulate sulphur deposition which can make up 30 % of the total sulphur deposition (Lindberg et al., 1986), and by sulphur leaching from senescent leaves, which also has been observed by Meiwes & Khanna (1981). Based on a comparison of throughfall data with deposition measurements of SO<sub>2</sub> and particulate sulphate on a large number of sites throughout the United States (Integrated Forest Study, IFS), Lindberg et al. (1990) and Johnson & Lindberg (1992) conclude that foliar leaching of SO<sub>4</sub><sup>2-</sup> contributed maximally 15% to the net throughfall flux of sulphate.

Several radioactive <sup>35</sup>SO<sub>4</sub><sup>2-</sup> studies have been conducted to evaluate the applicability of the throughfall method to estimate sulphur deposition (Garten et al., 1988; Lindberg & Garten, 1989; Cape et al., 1992; Wyers et al., 1994). Garten et al. (1988) added radiolabelled SO<sub>4</sub><sup>2-</sup> through single-stem well injection into the internal nutrient store of two Red Maple and two Yellow Poplar trees and analysed the amount of radiolabelled SO<sub>4</sub><sup>2-</sup> and total sulphate present in throughfall. During a 104-day period in the growing season, less than 10% of the net throughfall flux of sulphate could be accounted for by foliar leaching. Similar experiments with several individuals of Loblolly pine trees led to the same conclusion (Lindberg & Garten, 1989). Because the experiments conducted by Garten et al. (1988) and Lindberg & Garten (1989) were performed on isolated trees or trees situated at forest edges, the contribution of canopy leaching to net throughfall fluxes measured by these experiments may be larger in forest interiors (Fowler et al., 1992).

Cape et al. (1992) applied radioactive sulphate to the soil below a closed Scots pine forest canopy during a four month period in summer. Results suggest (assuming rapid equilibrium of <sup>35</sup>SO<sub>4</sub><sup>2-</sup> with sulphate in the soil) that root-derived sulphate contributed approximately 3% of sulphate in net throughfall and that dry deposition of SO<sub>2</sub> and sulphate particles contributed 97% to the total net throughfall flux of sulphate. However, there were some indications that equilibrium could not be safely assumed. For this reason, the possibility of a significant contribution of soil-derived sulphate to sulphate deposition in net throughfall could not be ruled out on the basis of this experiment (Cape et al., 1992).

At catchments at Lake Gardsjön on the Swedish west coast forested with Norway spruce, the deposition and watershed output has been studied during a period of 10 years by means of throughfall, precipitation and runoff measurements (Hultberg, 1985; Hultberg & Grennfelt, 1992). Runoff and throughfall sulphate fluxes were found to be very similar, suggesting uptake of sulphur by tree roots and transport to the tree canopy being of minor importance. Moreover, sulphate fertilization in several catchments did not enhance sulphate throughfall

fluxes significantly, supporting the hypothesis that sulphate throughfall provides a reasonable good measure for sulphur ( $\text{SO}_2 + \text{SO}_4^{2-}$  aerosol) deposition (Hultberg & Grennfelt, 1992). Similar conclusions were drawn by Likens et al. (1990) for catchments covered with deciduous forest at Hubbard Brook (USA).

### Nitrogen compounds

Present knowledge on canopy exchange of nitrogen compounds is limited due to the complexity of the exchange processes involved. Up to now, leaching of inorganic nitrogen from forest canopies has not been reported in the literature. On the contrary, numerous reports indicate that inorganic nitrogen may be taken up by canopy foliage, stems, epiphytic lichens or other microflora. Canopy foliage has been demonstrated experimentally to be capable of absorbing and incorporating gaseous  $\text{NO}_2$ ,  $\text{HNO}_3$  and  $\text{NH}_3$  as well as  $\text{NO}_3^-$  and  $\text{NH}_4^+$  in solution (Reiners & Olson, 1984; Bowden et al., 1989). In laboratory experiments,  $\text{NH}_4^+$  in solution was found to be exchanged with base cations present in leaf tissues (Roelofs et al., 1985). Epiphytic lichens were also shown to be active absorbers of  $\text{NO}_3^-$  and  $\text{NH}_4^+$  in solution (Lang et al., 1976; Reiners & Olson, 1984).

Based on information available in the literature, Ivens (1990) suggested the above ground uptake of total inorganic nitrogen by forests to be between  $150$  and  $350 \text{ eq ha}^{-1} \text{ yr}^{-1}$ , not clearly related to tree species. Within the Integrated Forest Study, Johnson & Lindberg (1992) measured throughfall and stemflow fluxes of  $\text{NO}_3^-$  and  $\text{NH}_4^+$  in several forest stands scattered over the United States. Simultaneously, dry deposition amounts of  $\text{NO}_2$ ,  $\text{NO}$ ,  $\text{HNO}_3$ ,  $\text{HNO}_2$ ,  $\text{NO}_3^-$ , and  $\text{NH}_3$  and  $\text{NH}_4^+$ , respectively, were estimated. Moreover, wet and cloud water deposition fluxes of nitrate and ammonium were determined. Canopy retention of inorganic nitrogen was estimated by total deposition (dry + wet + cloud water) minus soil flux (throughfall + stemflow). It was concluded that, on average, 40% of all inorganic nitrogen input to forests was retained by the vegetation, whereas 60% was found back in the throughfall as  $\text{NO}_3^-$  and  $\text{NH}_4^+$ . (Johnson & Lindberg, 1992). Total inorganic nitrogen uptake amounted to up to  $850 \text{ eq ha}^{-1} \text{ yr}^{-1}$ , with a strong positive relationship between deposition and uptake for spruce and spruce-fir stands. Other tree species showed a rather constant inorganic nitrogen uptake ( $200\text{-}300 \text{ eq ha}^{-1} \text{ yr}^{-1}$ ), with only little response to deposition amount (Johnson & Lindberg, 1992).

In the same study, part of the inorganic nitrogen retained by the canopy was supposed to be converted into organic substances and subsequently leached. Total nitrogen (organic + inorganic) in throughfall and stemflow was about 84% of the total inorganic nitrogen deposition (Johnson & Lindberg, 1992). Microbes were assumed to play an important role in the conversion of inorganic to organic N, if it occurs. However, it was recognised that organic N in throughfall also arises from internal pools and surfaces of plants and lichens, and from microparticulate detritus and pollen (Johnson & Lindberg, 1992). Atmospheric deposition of organic nitrogen compounds is estimated to be small, i.e.  $< 100 \text{ eq ha}^{-1} \text{ yr}^{-1}$  (Beringen et al., 1992). Carlisle et al. (1966) reported for a *Quercus petraea* stand an organic nitrogen throughfall flux of  $\pm 350 \text{ eq ha}^{-1} \text{ yr}^{-1}$ . Similar or somewhat larger throughfall fluxes of organic nitrogen were measured by Alenäs & Skärby (1988) in *Picea abies* forest stands.

More insight has been gained on nitrogen uptake by tree canopies by performing experiments with radio-labelled  $^{15}\text{N}$ . Bowden et al. (1989), for example, simulated cloud water deposition by fumigating *Pinus rubens* seedlings with a fine water spray. Essentially, they conclude that the total uptake of  $\text{NH}_4^+$  and  $\text{NO}_3^-$  ions from cloud water is small compared to the amount of nitrogen required to create new growth. Foliar retention of  $^{15}\text{NH}_4^+$  appeared to be larger compared to uptake of  $^{15}\text{NO}_3^-$ . Garten & Hanson (1990) applied radiolabelled  $\text{NH}_4^+$  and  $\text{NO}_3^-$  to *Acer rubrum* and *Quercus alba* through simulated rain. They concluded that  $^{15}\text{NO}_3^-$  deposited to deciduous tree leaves is easily removed by washing with water, while  $^{15}\text{NH}_4^+$  is retained and presumably assimilated into the leaf. Experiments with radiolabelled  $^{15}\text{N}$  made by Vose et al. (1989) show that foliar uptake of dry deposited  $\text{HNO}_3$  is small. In the Netherlands the fate of nitrogen within the forest canopy is also being studied by

the means of spraying labeled nitrogen (Slanina et al., 1990). However, no results have been published so far.

### **Sodium and chloride**

Although Fassbender (1977) reported some sodium uptake by young spruce trees during his laboratory experiments, sodium and chloride are normally considered to be more or less conservative elements showing only minor canopy exchange (Parker, 1983). In Germany, Bredemeier (1988) found a clear downwards gradient with increasing distance from the North Sea in sodium and chloride in bulk precipitation as well throughfall, indicating a major contribution of sea-salt particles to these fluxes. Ivens (1990) found a strong correlation between sodium and chloride in both bulk precipitation and throughfall samples, respectively, compiled from all over Europe. Sodium and chloride were found to occur in the same molar ratio as in sea water, i.e. 0.86. Moreover, sodium in throughfall was linearly related to sodium in bulk precipitation with an intercept of the regression line not significantly different from zero, suggesting nil canopy exchange (Ivens, 1990). Based on a comparison of throughfall data with deposition measurements on a large number of sites in the United States, Johnson & Lindberg (1992) also conclude that  $\text{Na}^+$  in throughfall may be considered as solely derived from atmospheric deposition. All these studies show the inertness of Na in the canopy.

### **Magnesium, calcium, potassium and phosphate.**

A substantial part of magnesium, calcium and potassium in throughfall is normally caused by canopy leaching (Parker, 1983). These ions are leached in association with foliar excretion of weak organic acid anions (Tukey, 1980; Hoffman et al., 1980) or through exchange with  $\text{H}^+$  and  $\text{NH}_4^+$  in leaf tissues (Roelofs et al., 1985).  $\text{K}^+$  is found to be relatively more susceptible to canopy leaching compared to  $\text{Mg}^{2+}$  and  $\text{Ca}^{2+}$  because it is not so tightly bound in structural tissues or enzyme complexes (Wood & Bormann, 1975). A literature compilation made by Parker (1990) indicates that it is not clear to which degree these base cations present in throughfall originate from atmospheric deposition and foliar leaching, respectively. Canopy leaching contributed between 10% and 80% to the total flux of these base cations reaching the forest floor. At coastal forest sites, magnesium in throughfall was predominantly caused by atmospheric deposition of sea-salts (Parker, 1983). Johnson & Lindberg (1992) suggest that calcium in throughfall may be enhanced at sites located in areas with calcareous soils or near calcium fertilized arable land. Observations done by White & Turner (1970), Abrahamson et al. (1976) and Alcock & Morton (1981) suggest that magnesium and calcium may also be irreversibly retained within the canopy. Ivens (1990) hypothesizes that canopy uptake may occur if tree canopies suffer from base cation deficiencies due to limited cation supplies from the soil.

Negligible amounts of phosphorus in ambient air suggest that canopy leachates contribute more than 90% to throughfall phosphate (Parker, 1983). Minor amounts of phosphate in throughfall may originate from soil dust, especially in forests situated near fertilized arable land. Furthermore, bird droppings may contribute to phosphate in throughfall (Van der Maas et al., 1990; Ivens, 1990), see also paragraph 3.3.1.6 of the ICP Forests Manual Part XVI Quality Assurance and Control in Laboratories.

### **Hydrogen**

Deciduous stands in regions remote from acid precipitation are usually found to have a higher throughfall pH in comparison to incident precipitation indicating canopy retention of protons (Parker, 1983). There are, however, a number of exceptions to this rule, especially at high acid deposition rates (e.g. Künstle et al., 1981; Skeffington, 1983). For coniferous stands, reports of higher throughfall pH (e.g. Abrahamsen et al., 1976; Miller, 1984) are as common as reports of lower pH (Parker, 1983).

In polluted areas remote from ammonia emission sources, throughfall is generally more acid than bulk precipitation (Georgii et al., 1986; Bredemeier, 1988). In the Netherlands, the proton flux under the forest canopy is found to be smaller than in the open field (Van Breemen et al., 1982; Houdijk, 1990; Ivens, 1990). This is attributed to canopy uptake of protons through exchange with cations like magnesium, calcium and potassium, and to the neutralising effect of dry deposition of ammonia onto the water layers present on the tree surface (Ivens, 1990).

### **Bicarbonate and organic compounds**

Bicarbonate in throughfall is usually found in regions away from acidified precipitation where it originates from atmospheric CO<sub>2</sub> (Cronan, 1978). In such regions, bicarbonate may even be the dominant anion because leachate cations commonly transfer as bicarbonate salts (Tukey, 1970). Partly, bicarbonate in throughfall may originate from canopy leaching of carbon or bird droppings (Parker, 1983).

A variety of organic compounds including sugars, amino acids, organic acids, hormones, vitamins, pectic and phenolic substances are probably leached from the canopy but difficult to measure due to their low stability in throughfall water and their high volatility (Parker, 1990).

#### **A1.2 An overview of models and methods available to estimate canopy exchange**

Several models have been developed to estimate canopy exchange. In many of these models canopy exchange is calculated solely on the basis of throughfall, stemflow and precipitation measurements. This is the case with (i) the regression model of Lovett and Lindberg (1984), (ii) the canopy budget model of Ulrich (1983) which was further developed by Bredemeier (1988) and Van der Maas and Pape (1991) using the 'filtering approach', (iii) the model of Beier et al. (1992) using the 'forest edge approach', (iv) models developed by Mayer and Ulrich (1974) and Miller et al. (1976) and the empirical model of Johnson and Lindberg (1992). Besides other models and methods have been used to estimate canopy exchange e.g. (i) the stomatal uptake model of Bouten and Bosveld (1992) and (ii) the inferential deposition model EDACS described by e.g. Erisman et al. (1994) and Erisman and Draaijers (1995). All mentioned models and methods are discussed below, focussing on the applicability for use within the Intensive Monitoring Program.

##### **Model of Lovett and Lindberg (1984)**

Monitoring throughfall and precipitation fluxes on an event basis allows the application of the regression model developed by Lovett and Lindberg (1984). This empirical model is based on the calculation of a multiple regression using event net throughfall (NTF) as the dependent variable and the duration of the antecedent dry period (DDP) and precipitation amount (P) as independent variables:  $NTF = b_1 * DDP + b_2 * P$ . The regression coefficients ( $b_1$  and  $b_2$ ) represent the mean dry deposition and canopy exchange rate, respectively. If information on the total duration of dry periods and the annual rainfall amount is available, these coefficients can be used to calculate yearly mean dry deposition and canopy exchange amounts. The model has proven very valuable for estimating canopy exchange and atmospheric deposition in forests situated in areas with convective storms and extended dry weather periods (e.g. Lovett and Lindberg, 1984; Puckett, 1990), but was found less useful in areas characterized by frequent low-intensity rainfall and relatively short dry periods (Lindberg et al., 1990; Ivens, 1990; Draaijers et al., 1994b). The model can only be used in case throughfall and precipitation are measured on an event-basis, which limits its application in the Intensive Monitoring Program.

### **Model of Ulrich (1983) and Van der Maas and Pape (1991)**

An alternative to regression modeling is application of the canopy budget model developed by Ulrich (1983), which was extended by Bredemeier (1988) and Van der Maas and Pape (1991). This model allows discrimination between canopy exchange and atmospheric deposition using long-term throughfall and precipitation fluxes, as is the case in the Intensive Monitoring Program. Dry deposition and canopy leaching of  $\text{Ca}^{2+}$ ,  $\text{Mg}^{2+}$  and  $\text{K}^+$  is computed by means of the so-called 'filtering approach', assuming a fixed relationship between wet and dry deposition of particles and taking  $\text{Na}^+$  as a tracer (Ulrich, 1983). The total canopy uptake of  $\text{H}^+$  and  $\text{NH}_4^+$  is taken equal to the total canopy leaching of  $\text{Ca}^{2+}$ ,  $\text{Mg}^{2+}$  and  $\text{K}^+$  taking place via ion exchange. Based on experiments in the laboratory (Van der Maas et al., 1991), it is assumed that  $\text{H}^+$  has per mol an exchange capacity six times larger than  $\text{NH}_4^+$ . Canopy exchange of  $\text{SO}_4^{2-}$  and  $\text{NO}_3^-$  is assumed to be negligible. A more detailed description of the model is presented by Draaijers et al. (1994b) and Draaijers and Erisman (1995) as well as in Appendix 1 of this paper. For the Speulder forest and other Dutch forests, the combination of throughfall measurements and application of the model resulted in deposition estimates, which were similar to deposition estimates derived from micrometeorological measurements and inferential modelling, deposition of  $\text{NO}_y$  being the only exception. The discrepancy found for  $\text{NO}_y$  could in part be explained by the (probably wrong) assumption that canopy uptake of oxidized nitrogen compounds is negligible. Up to now, several basic assumptions in the model (e.g. the ratio in exchange capacity between  $\text{H}^+$  and  $\text{NH}_4^+$ ) are not properly evaluated for different environmental conditions (tree species, ecological setting, pollution climate), which limits its application (Draaijers et al., 1994b; Draaijers & Erisman, 1995). Up to now the model has only been validated in relatively polluted areas as the Netherlands and Denmark.

### **Model of Beier et al. (1992)**

A major weakness of the 'filtering approach' is the assumed relation between wet and dry deposition of particles. To overcome this weakness a new approach was formulated by Beier et al. (1992), using  $\text{Na}^+$  to base cation ratios in fractions originating from the same process, i.e. dry deposition. Their approach can be used if throughfall and stemflow measurements are made both inside and near the edge of the forest stand ('forest edge approach'), which means that this approach can in general not be used within the framework of the Intensive Monitoring Program. The fraction of dry deposition to leaching inside the stand is estimated based on the assumptions that only <10% of the throughfall flux of  $\text{Ca}^{2+}$  and  $\text{Mg}^{2+}$  under the edge trees and >95% of  $\text{K}^+$  inside the stand are caused by leaching. The calculations of Beier et al. (1992) show that, especially for  $\text{Ca}^{2+}$  and  $\text{Mg}^{2+}$ , the influence of this choice is relatively small. However, process-oriented studies are necessary to obtain more precise knowledge on these properties for different environmental conditions.

### **Models of Mayer and Ulrich (1974) and Miller et al. (1976)**

Mayer and Ulrich (1974) took throughfall to precipitation flux ratios in winter to estimate dry deposition in summer, assuming canopy exchange only takes place in the summer period and trees have the same dry deposition catching efficiency in summer and winter. Miller et al. (1976) and Lakhani and Miller (1980) proposed to calculate canopy leaching from the intercept of the regression of bulk precipitation versus throughfall, assuming a functional relationship between wet deposition and dry deposition, and furthermore canopy exchange to be independent of wet and dry deposition. Considering present knowledge on canopy exchange and deposition processes, the assumptions underlying the approaches of Mayer and Ulrich (1974) and Miller et al. (1976) may be regarded questionable (Spranger, 1992; Erisman and Draaijers, 1995). For distinguishing canopy exchange and atmospheric deposition on the basis of throughfall and precipitation measurements, the 'multiple regression approach', 'filtering approach' and 'forest edge approach' can be considered much more reliable.



### Model of Johnson and Lindberg (1992)

An estimate for canopy uptake of oxidised and reduced nitrogen can also be obtained by using empirical results of the Integrated Forest Study (IFS) reported by Johnson and Lindberg (1992). Johnson and Lindberg (1992) found for 12 sites in the USA the above ground uptake of inorganic nitrogen,  $[CU_N]$ , significantly related to the total deposition of inorganic nitrogen,  $[TD_N]$ , according to:

$$[CU_N] = 0.41 * [TD_N] + 54.2 \quad (r^2 = 0.66) \quad [1]$$

For the same sites, the throughfall + stemflow flux of inorganic nitrogen,  $[TF_N+SF_N]$ , was significantly related to  $[TD_N]$ , according to:

$$[TF_N+SF_N] = 0.59 * [TD_N] - 54.2 \quad (r^2 = 0.80) \quad [2]$$

Combining equations [1] and [2] provides the relationship between the canopy uptake and the throughfall + stemflow flux of inorganic nitrogen (in  $eq\ ha^{-1}\ yr^{-1}$ ):

$$[CU_N] = 0.69 * [TF_N + SF_N] + 91.9 \quad [3]$$

Johnson and Lindberg (1992) made their measurements at sites situated in areas with relatively low air concentrations of N compounds in comparison to those found in certain areas in Europe. Throughfall + stemflow fluxes of inorganic nitrogen in the IFS ranged between 100 and 1000  $eq\ ha^{-1}\ yr^{-1}$ . Equation [3] therefore may only be applied for this range of inorganic nitrogen fluxes. It is not clear if uptake rates will increase linearly at higher throughfall + stemflow fluxes because nitrogen saturation in the canopy might be expected. Another restriction for using equation [3] is made by Johnson and Lindberg (1992) themselves. In their study the relationship between uptake and deposition appeared to be quite strong for spruce and spruce-fir forests but was found much less pronounced for other tree species. Canopy uptake of nitrogen will not only be governed by deposition amount but also by numerous other factors as was already explained in chapter 2.1. Process-oriented research on canopy uptake of nitrogen in relation to these factors is therefore recommended. While  $[TF_N + SF_N]$  gives a minimum estimate for nitrogen deposition,  $[TF_N + SF_N] - [CU_N]$ , with  $[CU_N]$  estimated according to equation [3], provides a more realistic estimate for nitrogen deposition to forests.

### Model of Bouten and Bosveld (1992)

For estimating stomatal uptake of gaseous nitrogen compounds ( $NO_2$ ,  $NO$ ,  $HNO_3$ ,  $HNO_2$  and  $NH_3$ ) a model developed by Bouten and Bosveld (1992) can be applied. This model uses air concentrations and meteorology as input data. Stomatal conductance is described as a product of response functions for water vapor deficit, global radiation, temperature, soil moisture status and leaf area index. To obtain realistic values for stomatal uptake of nitrogen compounds from the model of Bouten and Bosveld (1992), results from air concentration measurements made at or near the forest site under consideration need to be used. Diffuse samplers may be useful for measuring air concentrations due to the low costs involved and no need for electricity. Air concentration data representative for the large scale pollution climate (as collected e.g. within the framework of the EMEP Program) are of limited value for use at specific sites. Especially concentrations of oxidised and reduced nitrogen compounds have been found subject to considerable small scale variability as they are strongly influenced by local sources and climatic conditions. Meteorological measurements should ideally be performed at the site as well, but meteorological data can also be obtained from nearby sites part of a routine network. Due to the data necessary this model does not seem applicable for current use within the framework of the Intensive Monitoring Program.

### Model of Erisman et al. (1994)

Another estimate of nitrogen canopy uptake and base cation leaching can be obtained by comparing throughfall + stemflow fluxes with deposition estimates derived from inferential deposition models. Inferential deposition models like DEADM (Erisman, 1992) and EDACS (e.g. Erisman et al., 1994; Erisman and Draaijers, 1995) which are generally used to estimate atmospheric deposition on regional scales, also provide the possibility to estimate dry deposition to specific forest sites. In inferential models, dry deposition is calculated by multiplying air concentrations with dry deposition velocities. Dry deposition velocities are calculated from land-use and meteorological information using detailed parameterizations of the dry deposition process. To estimate dry deposition of nitrogen to specific forest sites, information is necessary on *i*) site characteristics (location, main tree species and tree height, *ii*) air concentrations ( $\text{NO}_2$ ,  $\text{NO}$ ,  $\text{HNO}_3$ ,  $\text{HNO}_2$ ,  $\text{NO}_3^-$  aerosol,  $\text{NH}_3$  and  $\text{NH}_4^+$  aerosol) and *iii*) meteorology (wind speed, temperature, dew point temperature or relative humidity, cloud cover and precipitation amount). Dry deposition estimates will improve if also information on canopy coverage, leaf area, tree density and/or distance to forest edges is available. Erisman (1992) used the DEADM model for estimating dry deposition to specific forest sites in the Netherlands. More recently, the EDACS model has been successfully applied to estimate dry deposition to forest sites in Germany (Van Leeuwen et al., 1996) and Europe (Draaijers et al., 1996). The EDACS model could be used to calculate nitrogen and base cation dry deposition for the Level II plots. Site characteristics can be obtained through PCC, air concentrations from EMEP (N compounds) or derived from precipitation concentrations in combination with scavenging ratios (base cations), and meteorological data from ECMWF.

#### A1.3. Major uncertainties and suggested activities for the future

From the overview in chapter 2 it can be concluded that within the framework of the Intensive Monitoring Program the following models are applicable for estimating canopy exchange: *i*) the canopy budget model of Ulrich (1983) and Van der Maas and Pape (1991), *ii*) the empirical model of Johnson and Lindberg (1992) and *iii*) the inferential model EDACS of Erisman and Draaijers (1995).

The canopy budget model of Ulrich (1983) and Van der Maas and Pape (1991) has proven very useful to estimate canopy exchange of the different components in relatively nitrogen polluted areas such as the Netherlands and Denmark but was up to now not validated under other pollution climates. Major uncertainties associated with this model are the wrong assumption of nil canopy uptake of oxidised nitrogen and the fixed uptake efficiency ratio between  $\text{H}^+$  and  $\text{NH}_4^+$  of 6, which in reality will vary according to the ecological setting of the forest.

The empirical model of Johnson and Lindberg (1992) can only be applied in areas with relatively low nitrogen pollution ( $< 1000 \text{ eq ha}^{-1} \text{ yr}^{-1}$ ). It is not clear if uptake rates will increase linearly at higher throughfall + stemflow fluxes because nitrogen saturation in the canopy might be expected. The relationship between uptake and deposition appeared to be quite strong for spruce and spruce-fir forests but was found much less pronounced for other tree species. Canopy uptake of nitrogen will not only be governed by deposition amount but also by numerous other factors as explained in Chapter 1. Process-oriented research on canopy uptake of nitrogen in relation to these factors is therefore recommended.

The inferential model EDACS of Erisman et al. (1994) can also be used to estimate of nitrogen canopy uptake and base cation leaching by comparing site-specific deposition estimates derived from the model with throughfall + stemflow fluxes. Deposition estimates from the EDACS model may be improved by using site-specific data on air concentrations and meteorology and by improving parameterisations to calculate dry deposition velocities. The latter are often derived from measurement made at one or only few sites and may not be representative for other ecological conditions and pollution climates.

In view of the above-mentioned uncertainties the following activities may be considered necessary to improve the canopy exchange estimates made within the framework of the Intensive Monitoring Program:

The uptake efficiency between  $\text{NH}_4^+$  and  $\text{H}^+$  should be investigated in relation tree species and ecological setting. This is possible by means of a relatively simple combined field and laboratory experiment. In summer, six first-order branches need to be collected from different trees using a branch cutter. The branches need to be transported to the laboratory in plastic bags immediately after cutting. The first order branches are subsequently cut into pieces through which several sub-samples are obtained. The different year classes of needles need to be represented in proportion to the amount present in the forest. The wounds resulting from cutting need to be connected to parafilm to prevent leakage of plant sap. About 80 g fresh plant material is put in plastic 1l bottles with a wide opening. The material is shaken for one hour with 900 ml distilled water to remove dry deposition from the branches. Subsequently the branches are shaken for 24 hours (with a speed of about 60 rpm) with 900 ml 100  $\mu\text{M}$  and 1000  $\mu\text{M}$  NaCl, HCl and  $\text{NH}_4\text{Cl}$  solution (in total six different solutions). For each solution at least 4 replicates need to be performed. Moreover, for each treatment two blanks are taken along, i.e. the same procedure is followed as described above but than without branches/plant material. The solution is analysed for pH,  $\text{Na}^+$ ,  $\text{K}^+$ ,  $\text{Mg}^{2+}$ ,  $\text{Ca}^{2+}$ ,  $\text{NH}_4^+$ ,  $\text{Cl}^-$ ,  $\text{NO}_3^-$  and  $\text{SO}_4^{2-}$ . The ratio of  $\text{H}^+$  and  $\text{NH}_4^+$  uptake for each site can be derived from the differences in exchange activity for the different concentration levels of the solutions (after Van der Maas et al., 1991). Ratios can be analysed in relation to tree species and ecological parameters also measured at plot. For one or several Level II plots also the seasonal variability in the ratio should be investigated by performing described combined field and laboratory experiment on a monthly basis. Mentioned experiment should be performed at every Level II plot or e.g. only at plots with strongly deviating pollution climates and ecological setting through which relationships between uptake efficiency ratios and parameters representing the pollution climate or the ecological setting can be derived. These relationships can be incorporated into the canopy budget model of Ulrich (1983) and Van der Maas and Pape (1991). For one or several Level II plots also the seasonal variability in the ratio should be investigated by performing described combined field and laboratory experiment on a monthly basis.

Process-oriented research on canopy exchange of oxidised and reduced nitrogen and base cations is necessary to derive relationships between canopy exchange and site parameters also measured within the Intensive Monitoring Program. An estimate of nitrogen uptake and base cation leaching for all Level II plots in Europe can be obtained by *i*) using the canopy budget model of Ulrich and Van der Maas and Pape (1991), *ii*) using the empirical relationship between uptake and deposition of Johnson and Lindberg (1992) and *iii*) comparing throughfall + stemflow fluxes with deposition estimates derived from the EDACS inferential deposition model. Site parameters for which relationships with canopy uptake need to be investigated include tree species, stand age, altitude, soil type, crown condition, foliar nutrient content, soil nutrient status and deposition amount. These relationships may e.g. be used to add a special module in the canopy budget model of Ulrich and Van der Maas and Pape (1991) on canopy uptake of oxidised nitrogen and to evaluate the empirical relationships between nitrogen canopy uptake and deposition derived by Johnson and Lindberg (1991), especially in relation to tree species and nitrogen deposition amounts larger than 1000 eq  $\text{ha}^{-1} \text{yr}^{-1}$ .

### **Appendix A1.1. The filtering approach**

Model assumptions and a short overview of the calculation scheme for the filtering approach are presented here. The following abbreviations are used: TF = throughfall flux, SF = stemflow flux, DD = dry deposition flux, BP = bulk precipitation flux, CL = canopy leaching, CU = canopy uptake, wa = weak organic acids (organic compounds with acidic properties, e.g. carboxylic acids, sulfonic acids, phenolic acids), cat = total cations, an = total anions, bc = sum of base cations  $\text{Ca}^{2+}$ ,  $\text{Mg}^{2+}$  and  $\text{K}^+$ . DDF = dry deposition factor and EF = excretion

factor. An appropriate time step for running the model is 0.5-1 year but, in principle, monthly data can be used as well. In the model, Na<sup>+</sup> in throughfall is assumed not to be influenced by canopy exchange. Furthermore, particles containing Ca<sup>2+</sup>, Mg<sup>2+</sup>, K<sup>+</sup>, Cl<sup>-</sup> and PO<sub>4</sub><sup>3-</sup> are assumed to have the same mass median diameter as Na<sup>+</sup> containing particles. Dry deposition of Ca<sup>2+</sup>, Mg<sup>2+</sup>, K<sup>+</sup>, Cl<sup>-</sup> and PO<sub>4</sub><sup>3-</sup> can subsequently be calculated according to (Ulrich, 1983):

$$DD = DDF * BP$$

The dry deposition factor equals:

$$DDF = (TF_{Na} + SF_{Na} - BP_{Na}) / BP_{Na}$$

Canopy leaching of these ions is calculated according to:

$$CL = TF + SF - BP - DD.$$

Canopy leaching computed for Cl<sup>-</sup> is regarded as deposition of HCl (gas) as Cl<sup>-</sup> leaching is generally assumed negligible (Draaijers, 1993). The total canopy uptake of H<sup>+</sup> and NH<sub>4</sub><sup>+</sup> is assumed to equal the total canopy leaching of Ca<sup>2+</sup>, Mg<sup>2+</sup> and K<sup>+</sup> minus canopy leaching of Ca<sup>2+</sup>, Mg<sup>2+</sup> and K<sup>+</sup> associated with foliar excretion of weak organic acids (canopy uptake should always balance canopy leaching). To calculate the latter, Van der Maas and Pape (1991) define an excretion factor equal to:

$$EF = CL_{wa} / (CL_{Mg} + CL_{Ca} + CL_{K})$$

where CL<sub>wa</sub> is computed according to:

$$CL_{wa} = TF_{wa} + SF_{wa} - BP_{wa} - DD_{wa}$$

It is assumed that all organic acids are leached in a neutral salt form. For the calculation of the excretion factor it is very important that all ions significantly contributing to the cation-anion balance are measured, and also with the highest possible accuracy (Van der Maas and Pape, 1991; Draaijers, 1993). TF<sub>wa</sub> is assumed equal to TF<sub>cat</sub>-TF<sub>an</sub>, SF<sub>wa</sub> equal to SF<sub>cat</sub>-SF<sub>an</sub> and BP<sub>wa</sub> to BP<sub>cat</sub>-BP<sub>an</sub> (e.g. Guiang et al., 1984). Dry deposition of weak organic acids is assumed equal to bulk precipitation of weak organic acids (Van Locht and Van Aalst, 1988). The canopy leaching of base cations through exchange with H<sup>+</sup> and NH<sub>4</sub><sup>+</sup> is computed according to:

$$CL_{bc} = (CL_{Mg} + CL_{Ca} + CL_{K}) * (1 - EF)$$

Canopy uptake of H<sup>+</sup> and NH<sub>4</sub><sup>+</sup> is subsequently calculated from the sum of exchanged ions of Ca<sup>2+</sup>, Mg<sup>2+</sup> and K<sup>+</sup> where it is assumed that, based on experiments in the laboratory (Van der Maas et al., 1991), H<sup>+</sup> has an exchange efficiency (= exchange activity) six times larger than NH<sub>4</sub><sup>+</sup>:

$$CU_H = CL_{bc} / (1 + (1 / [6 * (TF_H / TF_{NH_4})]))$$

$$CU_{NH_4} = CL_{bc} - CU_H$$

Knowing their canopy uptake, the dry deposition flux of H<sup>+</sup> (from H<sub>2</sub>SO<sub>4</sub>, (NH<sub>4</sub>)HSO<sub>4</sub>, HNO<sub>3</sub> and HCl) and NH<sub>4</sub><sup>+</sup> (NH<sub>3</sub> and NH<sub>4</sub><sup>+</sup> aerosol) can be computed from TF+SF+CU-BP. Finally, it is assumed that canopy leaching of SO<sub>4</sub><sup>2-</sup> and NO<sub>3</sub><sup>-</sup> is zero allowing the calculation of dry deposition of SO<sub>4</sub><sup>2-</sup> (SO<sub>2</sub> and SO<sub>4</sub><sup>2-</sup> aerosol) and NO<sub>3</sub><sup>-</sup> (NO, NO<sub>2</sub>, HNO<sub>2</sub>, HNO<sub>3</sub> and NO<sub>3</sub><sup>-</sup> aerosol) according to TF+SF-BP (Van der Maas and Pape, 1991).

It should be noted that the filtering approach assumes zero transformation of N-forms, which is not true (e.g. canopy nitrification, as shown by Guerrieri et al., 2015).

## Annex 2: Publications linked to collector and sampling design

Publications linked to collector and sampling design, and number of collectors for bulk, wet-only, throughfall and stemflow measurements

- Artz RS, Rolph GD, 1989, Evaluation of precipitation chemistry siting criteria using paired stations from Northern Maine and Southeastern Texas. *Atmos. Environ.* 23: 1033-1050. [https://doi.org/10.1016/0004-6981\(89\)90305-3](https://doi.org/10.1016/0004-6981(89)90305-3)
- Aussenac G, 1970. Action du couvert forestier sur la distribution au sol des précipitations. *Ann. For. Sci.* 27: 383-399. <https://doi.org/10.1051/forest/19700403>
- Beattie BL, Shaw RW, Whelpdale DM, 1988. Assessment of wet deposition monitoring in Atlantic Canada. *Atmosphere-Ocean* 26: 74-92. <https://doi.org/10.1080/07055900.1988.9649290>
- Beier C, Hansen K, Gundersen P, 1993. Spatial variability of throughfall fluxes in a spruce forest. *Environ. Pollut.* 81: 257-267. [https://doi.org/10.1016/0269-7491\(93\)90208-6](https://doi.org/10.1016/0269-7491(93)90208-6)
- Bellot J, Escarre A, 1998. Stemflow and throughfall determination in a resprouted Mediterranean holm-oak forest. *Ann. For. Sci.* 55: 847-865. <https://doi.org/10.1051/forest:19980708>
- Bigelow DS, 1991. Comparability of wet-only precipitation chemistry measurements from the United States' National Atmospheric Deposition Program (NADP) to those of the Canadian Network for Sampling Acid Precipitation (CANSAP). *Environ. Sci. Technol.* 25: 1867-1875.
- Bigelow DS, Sisterson DL, Schroder LJ, 1989. An interpretation of differences between field and laboratory pH values reported by the National Atmospheric Deposition Program/National Trends Network Monitoring Program. *Environ. Sci. Technol.* 23: 881-887.
- Bleeker A, Draaijers GPJ, van der Veen D, Erisman JW, Möls H, Fonteijn P, Geusebroek M, 2003. Field inter-comparison of throughfall, stemflow and precipitation measurements performed within the framework of the Pan European Intensive Monitoring program of EU/ICP Forest. *Environ. Pollut.* 125: 123-138. [https://doi.org/10.1016/s0269-7491\(03\)00142-8](https://doi.org/10.1016/s0269-7491(03)00142-8)
- Brandt CJ, 1989. The size distribution of throughfall drops under vegetation canopies. *Catena* 16: 507-524. [https://doi.org/10.1016/0341-8162\(89\)90032-5](https://doi.org/10.1016/0341-8162(89)90032-5)
- Brechtel HM, 1989. Monitoring wet deposition in forest – quantitative and qualitative aspects. In: *Monitoring Air Pollution and Forest Ecosystem Research*. AHM Bresser and P. Mathy (Ed.), Air Pollution Report Series 21: 39-63.
- Bücking W, 1982. *Sammel- und Analysenmethodik von Waldniederschlägen und Sickerwasser*. In: de Haar U, Hoffmann D (Hrg.): *Wasser aus dem Wald Wasser für den Wald. Ein Rundgespräch der Deutschen Forschungsgemeinschaft.* (= Beiträge zur Hydrologie/ Sonderheft, 4). ISBN 10: 3922749038 / ISBN 13: 9783922749035.
- Cape JN, 1989. Variability within forests in throughfall and stemflow. In: Bresser AHM and Mathy P. (Eds.) *Monitoring Air Pollution and Forest Ecosystem Research*. Brussels, Commission of European Communities. , CEC Air Pollution Report 21: 155-159.
- Cochran WG, 1977. *Sampling techniques*. Third edition. John Wiley & Sons, New York, USA.
- Czarnowski MS, Olszewski TJ, 1970. Number and spacing of rainfall-gauges in a deciduous forest stand. *Oikos*, 21: 48-51. <https://doi.org/10.2307/3543837>
- De Pena RG, Walker KC, Lebowitz L, Micka JG, 1967. Wet deposition monitoring – effects of sampling period. *Atmos. Environ.* 19: 151-156. [https://doi.org/10.1016/0004-6981\(85\)90146-5](https://doi.org/10.1016/0004-6981(85)90146-5)
- Draaijers GPJ, Bleuten W, 1989. Spatial variability of the atmospheric deposition onto forests on a local and regional scale level. In: *Brasser LJ, Mulder WC (Eds.): Man and his Ecosystem. Proceedings of the 8th World Clean Air Congress 1989, The Hague, The Netherlands, 11-15 September 1989, vol. 2: 195-200.*
- Draaijers GPJ, Erisman JW, Lövblad G, Spranger T, Vel E, 1998. Quality and uncertainty aspects of forest deposition estimation using throughfall, stemflow and precipitation measurements. TNO-Report TNO-MEP-R 98/093, TNO, The Netherlands, 73 p.

- Duijsings JJHM, Verstraten JM, Bouten W, 1986. Spatial variability in nutrient deposition under an oak/beechn canopy. *Zeitschrift für Pflanzenernährung und Bodenkunde*, 149: 718-727. <https://doi.org/10.1002/jpln.19861490608>
- Durocher MG, 1990. Monitoring spatial variability of forest interception. *Hydrological Processes*, 4: 215-229. <https://doi.org/10.1002/hyp.3360040303>
- Eschner AR, 1967. Interception and soil moisture distribution. In: Sopper, W.E., Lull, H.W. (Eds.), *Proceedings of the International symposium on Forest Hydrology*, August 29-September 10, Pergamon Press, New York, pp. 191-200.
- Ferm M, Larsson P-E, Svensson A, 2004. Kvaliteten i mätningarna av nederbördsmängd för de provtagare som används av IVL. Report IVL Svenska Miljöinstitutet, 14 pp.
- Ferretti M, Chiarucci A, 2003. Design concepts adopted in long-term forest monitoring programs in Europe - Problems for the future? *Sci Total Environ* 310: 171-178. [https://doi.org/10.1016/S0048-9697\(02\)00637-X](https://doi.org/10.1016/S0048-9697(02)00637-X)
- Graham RC, Oßal J, 1989. The non-parametric statistical evaluation of precipitation chemistry sampler intercomparison data. *Atmos. Environ.* 23: 1117-1130. [https://doi.org/10.1016/0004-6981\(89\)90313-2](https://doi.org/10.1016/0004-6981(89)90313-2)
- Graham RC, 1990. An assessment of performance of wet atmospheric deposition samplers part 2. Validation of siting criteria. *Water Air Soil Pollut.* 52: 97-114. <https://doi.org/10.1007/BF00283117>
- Guerrieri R, Vanguelova EI, Michalski G, Heaton THE, Mencuccini M, 2015. Isotopic evidence for the occurrence of biological nitrification and nitrogen deposition processing in forest canopies. *Glob. Change Biol.* 21, 4613-4626. <https://doi.org/10.1111/gcb.13018>
- Hanchi A, Rapp M, 1997. Stemflow determination in forest stands. *For. Ecol. Manag.* 97: 231-235. [https://doi.org/10.1016/S0378-1127\(97\)00066-2](https://doi.org/10.1016/S0378-1127(97)00066-2)
- Helvey JD, Patric JH, 1965. Canopy and litter interception of rainfall by hardwoods of Eastern United States. *Water Resources Research*, 1: 193-206. <https://doi.org/10.1029/WR001i002p00193>
- Hoppe E, 1896. Regenmessung unter Baumkronen. *Mitteilungen aus dem forstlichen Versuchswesen Österreichs*, K. K. Forstliche Versuchsanstalt Mariabrunn, Vienna, Austria, XXI, 75 pp. + annexes.
- Houle D, Ouimet R, Paquin R, Laflamme J-G, 1999. Determination of sample size for estimating ion throughfall deposition under a mixed hardwood forest at the Lake Clair Watershed (Duchesnay, Quebec). *Can. J. For. Res.* 29: 1935-1943. <https://doi.org/10.1139/x99-146>
- Houston TJ, Durrant DW, Benham SE, 2002. Sampling in a variable environment: selection of representative positions of throughfall collectors for volume and chemistry under three species in the UK. *Forest Ecology and Management*, 158: 1-8. [https://doi.org/10.1016/S0378-1127\(00\)00670-8](https://doi.org/10.1016/S0378-1127(00)00670-8)
- Kimmins JP, 1973. Some statistical aspects of sampling throughfall precipitation in nutrient cycling studies in British Columbian coastal forests. *Ecology*, 54: 1008-1019. <https://doi.org/10.2307/1935567>
- König N, Krinninger M, Schad T, Sanders TGM, Geppert F, Holzhausen M, 2021. Entwicklung und Test von Methoden zur Messung der nassen Quecksilberdeposition unter dem Kronendach von Wäldern. Texte 00/2021 Umweltbundesamt. <https://www.umweltbundesamt.de/publikationen/entwicklung-test-von-methoden-zur-messung-der>
- Konishi S, Tani M, Kosugi Y, Takanashi S, Sahat MM, Nik AR, Niiyama K, Okuda T, 2006. Characteristics of spatial distribution of throughfall in a lowland tropical rainforest, Peninsular Malaysia. *For. Ecol. Manag.* 224, 19-25. <https://doi.org/10.1016/j.foreco.2005.12.005>
- Kostelnik KM, Lynch JA, Grimm JW, Corbett ES, 1989. Sample size requirements for estimation of throughfall chemistry beneath a mixed hardwood forest. *J. Environ. Qual.*, 18: 274-280. <https://doi.org/10.2134/jeq1989.00472425001800030005x>
- Lawrence GB, Fernandez IJ, 1993. A reassessment of areal variability of throughfall deposition measurements. *Ecol. Appl.* 3: 473-480. <https://doi.org/10.2307/1941916>

- Levia DF, Frost EE, 2006. Variability of throughfall volume and solute inputs in wooded ecosystems. *Prog. Phys. Geogr.* 30: 605-632. <https://doi.org/10.1177/0309133306071145>
- Lloyd CR, de O Marques FA, 1988. Spatial variability of throughfall and stemflow measurements in Amazonian rainforests. *Agr. For. Meteo.* 42: 63-73. [https://doi.org/10.1016/0168-1923\(88\)90067-6](https://doi.org/10.1016/0168-1923(88)90067-6)
- Lousteau D, Berbigier P, Granier A, El Hadj Moussa F, 1992. Interception loss, throughfall and stemflow in a maritime pine stand. I. Variability of throughfall and stemflow beneath the pine canopy. *J. Hydrol.* 138: 449-467. [https://doi.org/10.1016/0022-1694\(92\)90130-N](https://doi.org/10.1016/0022-1694(92)90130-N)
- Ministère de l' Environnement, Direction de la météorologie, 1989: Réseau d' échantillonnage des précipitations du Québec, procédure de collecte des précipitations, 36+51 p.
- Neal C, Ryland GP, Conway T, Jeffrey HA, Neal M, Robson AJ, Smith CJ, Walls J, Bhardwaj CL, 1994. Interception of chemicals at a forest edge for a rural low-lying site at Black Wood, Hampshire, Southern England. *Sci. Total Environ.* 142: 127-141. [https://doi.org/10.1016/0048-9697\(94\)90321-2](https://doi.org/10.1016/0048-9697(94)90321-2)
- Neal C, 1990. Comments on "Sample size requirements for estimation of throughfall chemistry beneath a mixed hardwood forest". *J. Environ. Qual.* 19: 633-634. <https://doi.org/10.2134/jeq1990.00472425001900030051x>
- Nordic Council of Ministers, 1989. Methods for integrated monitoring in the Nordic Countries. *Miljørapport*, 11: 23-62.
- Pedersen LB, 1992. Throughfall chemistry of Sitka spruce stands as influenced by tree spacing. *Scand. J. For. Res.* 7: 433-444. <https://doi.org/10.1080/02827589209382736>
- Petersen DL, Rolfe GL, 1979. Notes: Determining sample size in throughfall studies. *For. Sci.* 25: 582-584. <https://doi.org/10.1093/forestscience/25.4.582>
- Puckett LJ, 1991. Spatial variability and collector requirements for sampling throughfall volume and chemistry under a mixed-hardwood canopy. *Can. J. For. Res.* 21: 1581-1588. <https://doi.org/10.1139/x91-220>
- Reynolds B, Neal C, 1991. Trough versus funnel collectors for measuring throughfall volumes. *J. Environ. Qual.* 20: 518-521. <https://doi.org/10.2134/jeq1991.00472425002000030003x>
- Robson AJ, Neal C, Ryland GP, Harrow M, 1994. Spatial variations in throughfall chemistry at the small plot scale. *J. Hydrol.* 158: 107-122. [https://doi.org/10.1016/0022-1694\(94\)90048-5](https://doi.org/10.1016/0022-1694(94)90048-5)
- Schwalter TD, 1999. Throughfall volume and chemistry as affected by precipitation volume, sapling size and defoliation intensity. *Great Basin Naturalist*, 59 1: 79-84. <https://scholarsarchive.byu.edu/gbn/vol59/iss1/6>
- Schroder LJ, Linthurst RA, Ellson JE, Vozzo SF, 1985. Comparison of daily and weekly precipitation sampling efficiencies using automatic collectors. *Water Air Soil Pollut.* 24: 177-187. <https://doi.org/10.1007/BF00285443>
- See RB, Schroder LJ, Willoughby TC, 1989. A quality-assurance assessment for constituents reported by the National Atmospheric Deposition Program and the National Trend Network. *Atmos. Environ.* 23: 1801-1806. [https://doi.org/10.1016/0004-6981\(89\)90063-2](https://doi.org/10.1016/0004-6981(89)90063-2)
- Seiler J, Matzner E, 1995. Spatial variability of throughfall chemistry and selected soil properties as influenced by stem distance in a mature Norway spruce (*Picea abies*, Karst.) stand. *Plant Soil* 176: 139-147. <https://doi.org/10.1007/BF00017684>
- Sirois A, 1990. The effects of missing data on the calculation of precipitation-weighted-mean concentrations in wet deposition. *Atmos. Environ.* 24: 2277-2288. [https://doi.org/10.1016/0960-1686\(90\)90321-D](https://doi.org/10.1016/0960-1686(90)90321-D)
- Sirois A, Vet R, 1999. The precision of precipitation chemistry measurements in the Canadian air and precipitation monitoring network (CAPMoN). *Environ. Monit. Assess.* 57: 301-329. <https://doi.org/10.1023/A:1006035129393>
- Sisterson DL, Wurfel BE, Lesht BM, 1967. Chemical differences between event and weekly precipitation samples in Northeastern Illinois. *Atmos. Environ.* 19: 1453-1469. [https://doi.org/10.1016/0004-6981\(85\)90283-5](https://doi.org/10.1016/0004-6981(85)90283-5)



- Staelens J, De Schrijver A, Van Avermaet P, Genouw G, Verhoest N, 2005. A comparison of bulk and wet-only deposition at two adjacent sites in Melle (Belgium). *Atmos. Environ.* 39: 7-15. <https://doi.org/10.1016/j.atmosenv.2004.09.055>
- Starr M, Ukonmaanaho L, 2000. Variation in throughfall amount and quality in relation to collector type and arrangement. European Programme for the Intensive Monitoring of Forest Ecosystems/Level II, Finland. Pilot study technical report (EU Project No 97.60.SF00.0), Finnish Forest Research Institute, Vantaa Research Centre, 28 pp.
- Starr M, Ukonmaanaho L, Sibley PK, Hazlett PW, Gordon AM, 2007. Deposition in boreal forests in relation to type, size, number and placement of collectors. *Environ. Monit. Assess.* 125: 123-136. <https://doi.org/10.1007/s10661-006-9245-2>
- Stedman JR, Heyes CJ, Irwin JG, 1990. A comparison of bulk and wet-only precipitation collectors at rural sites in the United Kingdom. *Water Air Soil Pollut.* 52: 377-395. <https://doi.org/10.1007/BF00229445>
- Thimonier A, 1998: Variabilité spatio-temporelle des dépôts atmosphériques d'éléments minéraux sous hêtraie. *Journal Forestier Suisse* 149: 585-614. [https://www.dora.lib4ri.ch/wsl/islandora/object/wsl%3A3593/datastream/PDF/Thimonier-1998-Variabilit%C3%A9\\_spatio-temporelle\\_des\\_d%C3%A9p%C3%B4ts\\_atmosph%C3%A9riques-%28published\\_version%29.pdf](https://www.dora.lib4ri.ch/wsl/islandora/object/wsl%3A3593/datastream/PDF/Thimonier-1998-Variabilit%C3%A9_spatio-temporelle_des_d%C3%A9p%C3%B4ts_atmosph%C3%A9riques-%28published_version%29.pdf)
- Thimonier A, 1998. Measurement of atmospheric deposition under forest canopies: some recommendations for equipment and sampling design. *Environ. Monit. Assess.* 53: 353-387. <https://doi.org/10.1023/A:1005853429853>
- Weihe J, 1974. Benetzung und Interception von Buchen- und Fichtenbeständen in Nordrhein-Westfalen – Die Regenmessung im Freiland mit Regenschreibern ohne Windschutz. *Allgemeine Forst- und Jagdzeitung* 145: 30-40.
- Weihe J, 1984. Benetzung und Interzeption von Buchen- und Fichtenbeständen – IV Die Verteilung des Regens unter Fichtenkronen. *Allgemeine Forst- und Jagdzeitung* 155: 241-252.
- Weihe J, 1985. Benetzung und Interzeption von Buchen- und Fichtenbeständen – V Die Verteilung des Regens unter Buchenkronen. *Allgemeine Forst- und Jagdzeitung* 156: 81-90.

### Annex 3: Simple guidelines for calculations

Conversion from ions to elements

Calculate the results to be reported in S, N and P using the formula	Element (atomic weight)	Ion (molecular weight)	Factor (element/ion)
	S (32.065 g)	SO <sub>2</sub> (64.064 g)	0.5005
concentration of element = factor x concentration of ion	S (32.065 g)	SO <sub>4</sub> <sup>2-</sup> (96.063 g)	0.3338
	N (14.0067 g)	NO <sub>2</sub> <sup>-</sup> (46.0055 g)	0.3045
	N (14.0067 g)	NO <sub>3</sub> <sup>-</sup> (62.0049 g)	0.2259
where:	N (14.0067 g)	NH <sub>4</sub> <sup>+</sup> (18.0385 g)	0.7765
	P (30.9738 g)	PO <sub>4</sub> <sup>3-</sup> (94.9714 g)	0.3261
atomic weight of element factor = ----- formula weight of ion			

#### Calculation of mean pH

The original pH values must be converted to where:  
 conc H<sup>+</sup> before calculation - the mean conc  
 H<sup>+</sup> is then reconverted to a pH-value:

$\bar{H}^+$  = mean proton activity

$^p H_i$  = pH-values of samples

n = number of samples

$$\bar{H}^+ = 1/n \sum_{i=1}^n 10^{-pH_i}$$

$$\bar{pH} = -\log_{10}(\bar{H}^+)$$

#### Calculation of volume weighted means

Weighted means for precipitation (precipitation, throughfall and stemflow) chemistry are calculated using the formula:

$$\bar{X} = \frac{\sum c_i m_i}{\sum m_i}$$

where:

c = measured concentration during a period

m = precipitation during the period

*Guidelines to calculate quantities in mm from stemflow volumes*

The volumes of the stemflow are measured in litres per tree per period. In order to calculate the total deposition per hectare it is necessary to recalculate these volumes into volumes per period. The volumes are to be reported in mm per period.

As only a limited number of trees (e.g. 5) are measured for stemflow, an estimate has to be calculated for the total stemflow for all trees in the plot.

It is recommended to use the following method to calculate the total stemflow per hectare per year. It is based on the total basal area of the trees used for the stemflow measurements and the total basal area of all the trees in the plot (of 0.25 ha). Guidelines for calculating the basal area are given in the sub-manual on growth ([www.icp-forests.org/manual](http://www.icp-forests.org/manual)).

The formula used is:

$$\text{Total volume in the plot} = (\text{Total stemflow of } n \text{ trees}) * \frac{\text{Total basal area of all trees in the plot}}{\text{Total basal area of the } n \text{ trees}}$$

where:

n is the number of trees used for the stemflow measurements (e.g. 5)

the Total stemflow of n trees is stated in litres

the Total basal area of all trees in the plot is stated in m<sup>2</sup>

the Total basal area of the n trees is stated in m<sup>2</sup>

The result (in litres) is then divided by the plot area (in hectares) to calculate the total volume per hectare. Division with 10 000 results in the quantity in mm.

This should be reported per measuring period.

## Annex 4: Procedures for ensuring high quality analytical results

The following suggestions and recommendations concerning measurements and analytical methods are based on the results and workshops of the first and second Working Ring Tests on Atmospheric Deposition and Soil Solution carried out in 2002 and 2005 within the framework of the ICP Forests Expert Panel on Deposition (Mosello et al. 2002, Marchetto et al. 2006). They do not necessarily refer directly to the analytical methods or procedures actually used in each laboratory, but are intended as suggestions and general guidelines for the correct application of the methods.

### A4.1. pH

#### *Calibration*

This must be carried out with two buffer solutions, the pH values of which cover the range of pH values expected in the samples.

The temperature and stirring (or not stirring) conditions must be the same for the buffer solutions and for the samples.

Calibration can be done at weekly intervals if the pH meter is not turned off after each batch of measurements, and if other conditions (e.g. temperature, voltage) are kept constant. However the accuracy of this must be checked and validated by the laboratory.

Read and follow carefully the instructions given for calibration in the pH meter manual.

#### *Measurement*

Measurement is performed on unfiltered samples (as stated in ISO 10523).

The electrodes must be rinsed with pure water and then with the next sample to be measured in order to prevent contamination from the previous sample.

Initial agitation of the sample for at least one minute is recommended; the measurement may be made on the stirred or quiescent sample as described in point 7.3.1. of ISO 10523).

Stabilisation of the reading should be achieved within 5-10 minutes. A longer stabilisation time indicates either problems with the electrode, or that the sample or standard has not become stabilised with the laboratory atmosphere.

The use of either low flow (GLF) or high flow (GHF) glass electrodes seems, in most cases, to be unimportant. Good quality and maintenance of the pH electrode are more relevant.

Separate equipment (electrodes) must be used for “clean” and “dirty” samples. Avoid the use of pH electrodes designed for meat or cheese.

#### *Maintenance*

The electrode must be stored as indicated by the manufacturer, normally in 3M KCl. Do not use de-ionised water or buffer solutions.

Follow carefully the instructions for the maintenance of the solution inside the electrode.

#### *General*

Do not measure conductivity or carry out chemical analyses on the same solution on which pH has been measured. The same sample can be used provided that conductivity is measured first.

Several textbooks and papers are available on pH measurement, and guidelines for correct measurement are given in most analysis handbooks (e.g. A.P.H.A., A.W.W.A., W.E.F., (1998); Westcott, (1978).

## A4.2. Total alkalinity

### A4.2.1. Definition of total alkalinity

The alkalinity of a solution is its capacity to neutralise acids, defined as the amount of acid needed to neutralise the bases present in the solution itself. Alkalinity is then the sum of all the bases in the sample, and is determined by means of an acidimetric titration. In freshwater or precipitation, these bases are primarily bicarbonate, as well as hydroxyl ions at pH values above 8.0, sulphide and non-ionic compounds such as calcite or certain organic compounds.

Figure A4.1 shows the evolution of pH, its first derivative and the concentration of hydrogen ions during an acidimetric titration. The critical point in the titration is the determination of the equivalent point, where it can be assumed that all the bases have been neutralised. If we assume that the main base in solution is bicarbonate, then the equivalent point is the inflection point of the titration curve between bicarbonate and carbonic acid + carbon dioxide (Stumm & Morgan 1981). This value depends on the CO<sub>2</sub> concentration in solution at this point, which is a function of the total concentration of the carbonate system. Consequently, the equivalence point of the alkalinity titration depends on the alkalinity to be determined (Kramer et al. 1986), and it ranges between pH 5.0 and 5.6.

To detect the inflection point, it is possible to monitor the pH and to plot the titration curve and its first derivative during the titration. This technique is difficult and often not precise at very low alkalinity for the difficulties related to the choice of suitable added volumes and for the slow response of pH electrodes.

For this reason some techniques were developed to estimate the equivalence point indirectly. The most used are the Gran method (Gran 1952) and the titration with two fixed end-points, spaced 0.3 pH units, which are described in this chapter.

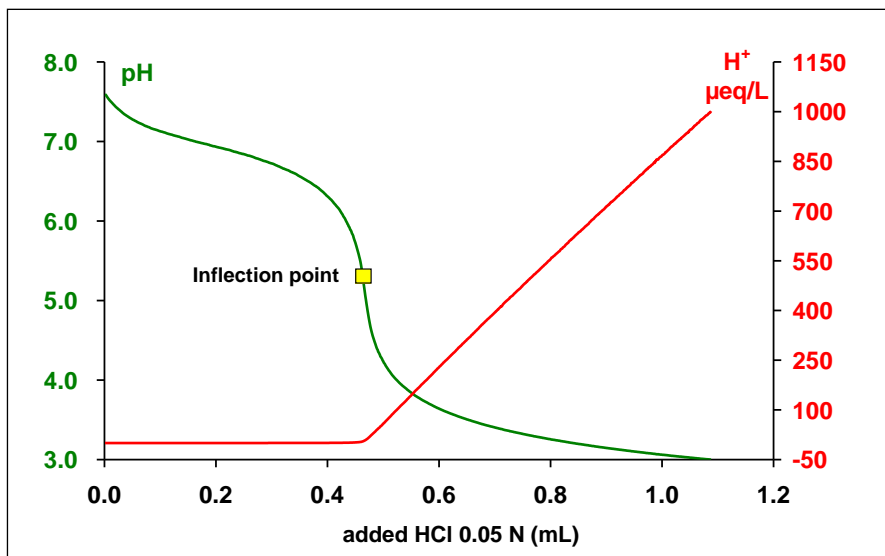

Figure A4.1: Plot of pH and hydrogen ion concentration during an acidimetric titration.

## A4.2.2. Two end points titration

This technique requires the continuous reading of pH during titration. Acid (with normality  $N_{Ac}$ ) is added after the equivalence point, leading the pH of the solution to decrease down to 4.5 (or less), where the titration is stopped (first end point) and the first volume ( $V_1$ , in mL) noted (Figure A4.2). Then acid is added again until the pH decreases of exactly 0.3 units. This is the second end point, and the total volume added ( $V_2$ , in mL) is noted again.

A decrease in pH of 0.3 units means a doubling of the hydrogen ion concentration, and simplifies the calculation of alkalinity at the equivalence point, which simply results

$$\text{Total alkalinity (meq L}^{-1}\text{)} = \frac{(2V_1 - V_2) \times N_{Ac} \times 1000}{\text{Sample volume (ml)}}$$

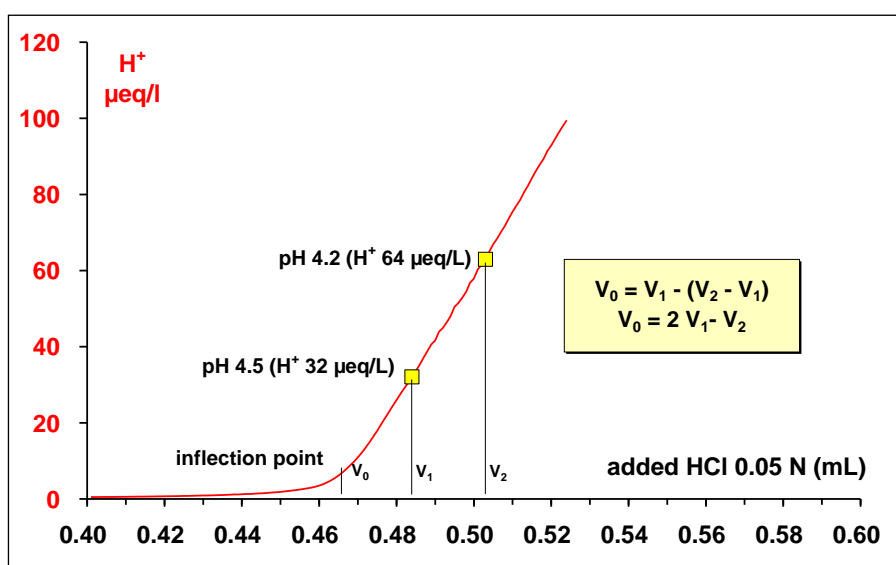

**Figure A4.2:** Plot of the concentration of hydrogen ions during the final part of an acidimetric titration, showing the extrapolation to the equivalence point, i.e. the intercept on the x-axis of the line straight line passing through the two end points.

## A.4.2.3. The Gran method

This is the most precise technique to measure alkalinity and is very much recommended for low values (Gran 1952).

After adding enough acid to drive the pH down to 4 units or less, a number of acid additions (10-30  $\mu\text{L}$ ) are performed and pH is measured. At each point, the following function is calculated:

$$\text{Gran's } F_1 = (\text{sample volume} + \text{added volume}) \cdot 10^{-\text{pH}}$$

A regression line between Gran  $F_1$  and added volume is then calculated, with an intercept point to the x-axis at the equivalence point  $V_0$  (Figure A4.3).

Total alkalinity is then calculated as follows:

$$\text{Total alkalinity (meq L}^{-1}\text{)} = \frac{V_0 \times N_{Ac} \times 1000}{\text{sample volume (ml)}}$$

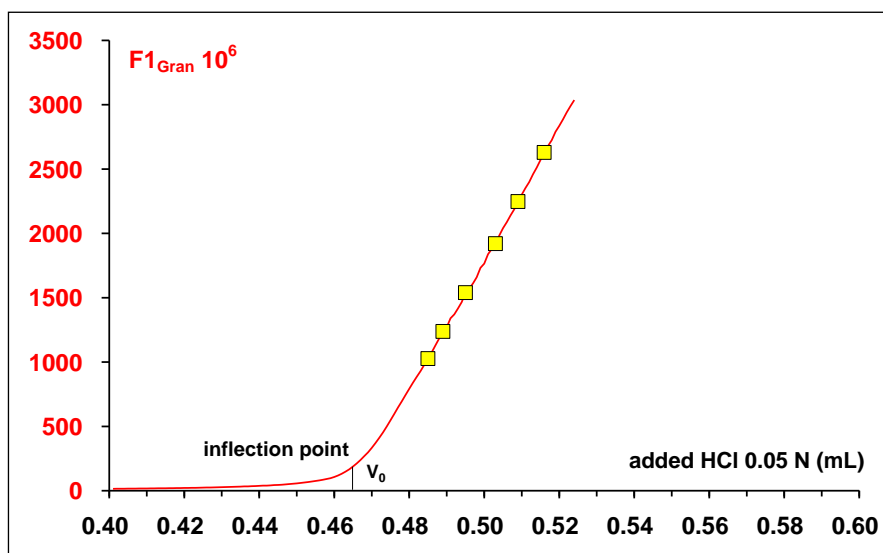

Figure A4.3: Plot of Gran titration.

#### A4.2.4. Suggestions for a correct titration

Within the alkalinity range 0-5 meq L<sup>-1</sup>, if the sample volume is around 30-75 ml it is possible to use an acid solution 0.05 N.

Refrigerated samples, and calibration buffers, should be let to warm to 18-24°C before titration. The pH meter has to be calibrated before titration, at least weekly.

It is important to take care of electrode rinsing, both with de-ionized water and with the sample or the calibration buffer, before starting reading.

Any air bubble in the acid should be eliminated by adequate purging.

The concentration of the acid should be verified before the first titration, and then at least every six months, measuring samples with known alkalinity.

### A4.3. Conductivity

Conductivity is a master variable for the quality control of chemical analyses (see Chapter 7.3). It is a rapid measurement that gives valuable information on the nature of the water sample, primarily the concentration of solutes.

The type of errors made in the measurement of conductivity are typically systematic, due to poor calibration of the equipment; random errors may be due to a lack of care in rinsing the electrodes.

Conductivity is strongly dependent on the temperature of the sample. The reference temperature is +25°C. Many instruments are equipped with temperature compensation. Such instruments should be calibrated strictly in accordance with the manufacturer's instructions. If the instrument does not have automatic compensation for temperature, correction factors must be used. Correction tables are available in most water analysis standards and manuals (see below).

A small systematic error is introduced when either automatic or manual corrections are used, as the correction factors apply to water samples with the chemical characteristics of surface water, where the ranking of concentrations of individual cations and anions is usually Ca > Mg > Na > K, and HCO<sub>3</sub> > SO<sub>4</sub> > Cl > NO<sub>3</sub>. The chemical characteristics of bulk deposition, throughfall and stemflow are usually different.

The calibration of the equipment should be regularly checked every six months using KCl solutions, as indicated in the main water analysis references (e.g. ISO 7888-1985; A.P.H.A, A.W.W.A. & W.E.F. 1998). Of course a higher calibration frequency is needed if the same instrument measures very polluted samples (e.g. sewage), but this should be avoided, as far as possible.

#### **A4.4. ICP and AAS-flame determinations**

##### A4.4.1. ICP/OES

###### *Calibration/blank*

Generally the calibration curve is linear over 5-6 decades. It is usually sufficient to carry out a 2-point calibration if the linearity has been checked. The calibration must be verified with an independent control sample.

It is important to check the purity of the blank (Note! The use of glassware may release sodium).

Depending on the measuring time, a control sample should be measured every 10 to 20 samples in order to maintain drift and carry-over control.

###### *Automatic sampler/carry-over*

The use of automatic samplers can cause contamination of samples and standards because the containers in the sampler are open for a considerable period of time. Carry-over from preceding samples into blanks may also occur. These problems can be minimized by covering the sampler, and by frequent replacement of the blank solution.

The rinse time (with rinsing solution) has to be sufficient to avoid carry-over between samples. The aspiration time of the sample has to be sufficiently long to reach equilibrium in the mixing chamber and in the plasma.

###### *Matrix/addition of acid*

The standards should be adjusted to correspond to the matrix of the samples. This is especially important for standards containing only one element in trace amounts.

All samples and standards have to be acidified in a consistent manner (0.5 - 3 ml of conc. HNO<sub>3</sub>/100 ml sample).

###### *Background correction*

Background correction is normally necessary. To set the points for the background correction, all possible interfering elements have to be taken into account and tested.

###### *Inter-element correction (IEC)*

Inter element-correction interferences, caused by line overlay, can be minimised by numerical methods. Exact determination of the correction factors for the type of line overlay is necessary.

###### *Internal standard*

The use of internal standards is normally helpful. Problems caused by oscillations of the plasma and the physical influence of the sample matrix can be compensated to a large extent. The different behaviour of atom lines and ion lines has to be taken into account.



The sample may not contain the element used for the internal standard. The same amount of internal standard solution has to be added to all the samples and standard solutions. This can normally be automated.

#### *Radial or axial plasma*

The sensitivity can be increased ten times by using axial plasma.

Because of ionisation effects, the measurement of alkaline elements is very problematic. These interferences can be reduced by adding an ionisation buffer.

#### *Ultrasonic nebulizer (USN)*

The use of an USN can increase the sensitivity 2-5 times.

The USN is highly sensitive to matrix influences. Matrix homogenisation by the addition of e.g. CsCl gives clearly better results.

**Table A4.1: Selection of wavelength in ICP/OES determinations**

Element	Wavelength proposed by DIN EN ISO11885	Remarks
Ca	317.933 315.887 393.366	Sensitive, ionisation buffer important with axial plasma (Fe interference at 317.933)
Mg	285.213 279.079 279.553	Interference only with a high matrix concentration
Na	589.592 588.995 330.237	Not very sensitive and very difficult to analyse by axial plasma; ionisation buffer important
K	766.490 769.900	Not very sensitive and very difficult to analyse by axial plasma; ionisation buffer important
Al	396.152 167.08 308.215	Contamination problems at low concentrations (OH interference at 308.215)
Mn	257.610 293.306	Acid addition important at low concentrations in order to minimise memory effects
Fe	259.940 238.20	Acid addition important at low concentrations in order to minimise memory effects
Cu	327.396 324.754	Problems with USN; matrix and acid concentration have an effect; important to add an alkali or earth alkali element (e.g. Cs or Ca) (Fe interference at 324.754) (OH interference at 324.754; can be minimised by using USN)
Zn	206.191 213.856	Contamination problems (Fe interference at 213.856)
P	178.287 213.618 214.914	Not very sensitive
S	182.036 180.669	Problems with USN; influence of matrix (Ca interference at 180.669)

#### A4.4.2. AAS

##### *Calibration/blank*

Normally the calibration curve is linear over 2-3 decades. Calibration has to be verified using an independent control sample.

It is important to check the purity of the blank (Note! The use of glassware may release sodium).

In order to control the drift of the measurement a control sample should be measured every 15-30 samples (depending on the element and burner type).

#### *Automatic sampler/carry over*

The use of an automatic sampler can cause carry over from samples into the blank solutions. This problem can be minimised by frequent replacement of the blank solution.

#### *Matrix/additives*

The standards should be adjusted to correspond to the matrix of the samples.

Additives are necessary for the determination of some elements in order to avoid ionisation interference and oxide formation. A mixture of La and Cs can be used to remove all interferences for Na, K, Ca and Mg (0.2 % La and 0.02 % CsCl).

#### *Background correction*

Measuring the background is not normally necessary for water samples.

#### *Burner/gas*

An air/acetylene flame or a N<sub>2</sub>O/acetylene flame and a corresponding burner are used for a number of elements (see Table 7).

**Table A4.2: Selection of wavelength in AAS determinations.**

Element	Wave-length	Remarks
Ca	422.7	Small slit (interference NO); Flame: N <sub>2</sub> O/acetylene, Cs additive important (if using a reducing air/acetylene flame, then La addition is needed)
Mg	285.2 (202.5)	Very sensitive at 285.2; crosswise burner possible at 285.2; Flame: air/acetylene; La additive is needed (if using a N <sub>2</sub> O/acetylene flame, then Cs addition is needed)
Na	589.0 (589.6)	Contamination problems; Cs addition important (can also be measured by AES-Flame)
K	766.4 (769.9)	No problems; Cs addition important (can also be measured by AES-Flame)
Al	309.3	Not very sensitive; Flame: N <sub>2</sub> O/acetylene (the correct stoichiometry of the flame is important); Adjustment of the burner important; Cs addition important
Mn	279.5	No problems
Fe	248.3	No problems with water samples; Small slit needed (many interferences)
Cu	324.7	No problems
Zn	213.8	No problems
P	---	No direct method available
S	---	No direct method available

#### A4.5. Dissolved organic carbon (DOC)

In natural waters, total organic carbon (TOC) is the sum of particulate and dissolved organic carbon. Dissolved organic carbon (DOC) is operationally defined, usually as organic carbon that passes through a 0.45 µm membrane filter. Note that analysers may contain an internal protective filter which could have a smaller pore size (e.g. 0.2 µm). Cellulose acetate or nitrate filters should not be used for this purpose due to contamination or adsorption problems. Filter paper may contaminate the sample with NH<sub>4</sub> and organic carbon. Glass fibre filters are preferable. The possible release of organic fibres from the membrane used should be tested, and suitable pre-rinsing procedures developed if required.

Although the discussion below concerns DOC, much of it applies to TOC as well. Organic carbon is most often determined after oxidation to CO<sub>2</sub> using combustion, an oxidant such as persulphate, UV or other high-energy radiation, or a combination of some of these. If only UV radiation with oxygen as oxidant is used, underestimates of the DOC concentration may be obtained in the presence of humic substances. A variety of methods are used for detection, including infrared spectrometry, titration and flame ionisation detection after reduction to methane. Always follow the instrument manufacturer's instructions.

For the determination of DOC, dissolved inorganic carbon (DIC) must be either removed by purging the acidified (for example with phosphoric acid) sample with a gas that is free from CO<sub>2</sub> and organic compounds, or determined and subtracted from the total dissolved carbon. If acidification followed by purging is used, care should be taken, as volatile organic compounds may also be lost. After acidification, the CO<sub>2</sub> is removed by blowing a stream of pure carbon-free inert gas through the system for at least 5 minutes.

For calibration, standard solutions are most often potassium hydrogen phthalate for total dissolved carbon and sodium bicarbonate/sodium carbonate for dissolved inorganic carbon. The DOC concentration should be within the working range of the calibration. If necessary the sample can be diluted.

DOC may also be determined by UV absorbance. A typical absorbance spectrum for DOC is shown in Figure A4.4. At higher wavelengths absorbance is lower, so care should be taken when measuring in this region.

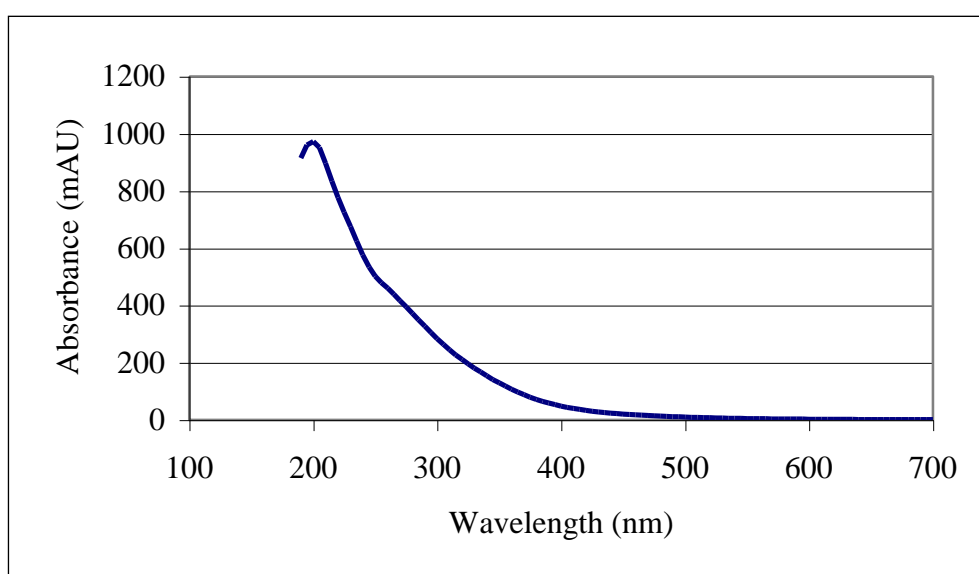

Figure A4.4: Absorbance spectrum of DOC.

DOC may be determined by absorbance at 254 nm (Brandstetter et al. 1996). This is not the optimal method, but may be used if a carbon analyser is not available. Regression equations are given by Brandstetter et al. for estimation of DOC from the absorbance measurements:

$$\text{DOC (mg/l)} = 0.44 A_{254} (\text{m}^{-1}) + 0.9 \text{ for throughfall}$$

$$\text{DOC (mg/l)} = 0.86 A_{254} (\text{m}^{-1}) - 11.7 \text{ for stemflow}$$

where  $A_{254}$  = absorbance at 254 nm.

For wet deposition, an equation is given by Bartels (1988):

$$\text{DOC (mg/l)} = 0.46 A_{254} (\text{m}^{-1}) - 0.10$$

Carbon is ubiquitous in nature, so reagents, water, and glassware cannot be completely cleaned of it. Method interferences (positive bias) may be caused by contaminants in the carrier gas, dilution water, reagents, glassware, or other sample processing hardware (for example a homogenisation device). All of these materials must be routinely demonstrated to be free from interference under the conditions of analysis by running reagent blanks.

Plastic bottles can bleed carbon into water samples, especially when they are new or starting to degrade, or when they are used for low-level samples (less than 200 ppb C). Any new bottles (especially plastic) should ideally be filled with clean water for a period of several days or boiled in water for a few hours before use. Glass or high-density polyethylene bottles are recommended. The use of high purity or purified reagents and gases helps to minimise interference problems. It is very important to use ultra-pure water with a carbon filter or boiled distilled water just before preparing stock and standard solutions, in order to remove dissolved  $\text{CO}_2$ . The stock solution should not be kept too long (about one week). For most DOC instruments a correction for DOC (due to dissolved  $\text{CO}_2$ ) in the dilution water used for calibration standards is necessary, especially for standards below 10 ppm C. The carbon in the blank should only be subtracted from standards and not from samples.

Sample DOC concentrations below about 50 ppb C can be affected by atmospheric exposure. In these cases, sampling bottles should be kept closed whenever possible, and autosampler vials should be equipped with septa for needle piercing by the autosampler.

#### **A4.6. Spectrophotometric determination and flow systems**

##### *General remarks*

Samples to be analysed by spectrophotometric methods should not be turbid or of a colour that interferes with the determination. Turbidity should not normally be a problem because all samples are filtered through a 0.45  $\mu\text{m}$  membrane filter prior to analysis. However, turbidity may subsequently develop by the time the samples are to be analysed. The problems associated with turbid or coloured samples can be eliminated in a number of ways:

Make sure that all the samples are free from particles by refiltration (0.45  $\mu\text{m}$  membrane) prior to the analysis,

The colour can be removed from solutions by means of sorptive materials (e.g. C18) or dialysis. Dialysis can be performed statically in dialysis tubes or dynamically by means of a dialysis membrane in a flow cell with an upper and top stream (usually a component of CFA Systems)

Colour compensation can also be employed; this is most common in manually performed spectrophotometric measurements. The zero point of the photometer is adjusted with a sample containing all the components of the colorimetric method but without the colour reagent. Repeated measurement of the same sample including the colour reagent results gives an absorption measurement that is not affected by the colour of the sample.

The linearity of the working range for spectrophotometric methods is typically given over 1 decade of concentration. Absorption intensity is influenced by the length of the optical path, the concentration ratio between sample and colour reagent, the temperature of the measured solution, and the reaction time between the addition of the colour reagent to the sample solution and the start of the absorption measurement.

The measurements can be performed in manual mode or in flow systems (SCFA or FIA).

The advantages of a flow system are:

- The measurements can be made in an automated system with high sample throughput.
- All conditions (volume dosage, temperature and colour development time) are well reproducible because they are controlled by the system conditions.
- Sample preparation procedures (dialysis, thermal, UV and peroxide dissolution, reduction reaction prior to colour development) are fully integratable.
- Detection can be performed as absorption measurement (increasing or decreasing) or based on potentiometry (ISE).

The selectivity and sensitivity of photometric and flow system methods are rather high. In some cases, however, there can be problems.

#### *Reagents*

All reagents should be of “analytical grade”. Check solution stability with respect to the solubility of salts (non-saturated solutions). Store the reagent solutions in a cool dark place, and degas the reagent solutions prior to analysis by stirring, helium-degassing, membrane filtration (under pressure) or ultra-sonic treatment of the reagent bottles.

#### *Calibration*

Calibration prior to the start of daily analysis should be performed using at least five calibration standards per working range; this should be verified by means of an independent control sample. Check the precision and stability of photometers and flow systems by replicate measurement of calibration or verification standards every 15<sup>th</sup> to 20<sup>th</sup> sample. Some instruments can perform automatic drift correction by replicated measurements of standards after a predefined number of samples.

**Table A4.3: Information about photometric and flow methods.**

Parameter	Method	Remarks
Sulphate	Ba/Ca Methyl-Thymol blue	2-channel method: absolute simultaneous flow of the Ba and Ca channel is required. The signal is obtained as the absorption difference between the two channels. As no dialysis pre-treatment is possible, there is no membrane available for good SO <sub>4</sub> diffusion. High concentrations of cations cause problems.
Nitrate	Sulphanilamide Cd or hydrazinium reduction	High concentrations of Fe, Cu and other metals cause problems in analysis; add EDTA to the buffer solution to prevent problems. When a Cd-reduction column is used, ensure that the column is completely degassed and avoid drying out of the Cd granules.
Chloride	Hg-Fe-SCN potentiometry	Bromide and iodide cause interference at concentrations exceeding 30 mg/l. Sulphide ions also cause interference. Ensure that Hg-containing waste solution are collected and recycled in accordance with environmental regulations.
Ammonium	Indophenol blue	High amino acid concentrations increase the measured

Parameter	Method	Remarks
	Gas Diffusion	ammonium concentration. High Mg concentrations cause precipitation of $Mg(OH)_2$ ; add sodium citrate to avoid the problem.
$N_{total}$	Sulphanilamide Cd or hydrazinium reduction	After oxidation, detection of $N_{total}$ as nitrate. High concentrations of Fe, Cu and other metals cause problems in analysis; add EDTA to the buffer solution to avoid this problem. Use calibration standards containing $NH_4$ and $NO_3$ components.
Phosphate	Molybdenum blue	Reducing components can interfere. Silicates cause problems; the same molybdenum-blue complex is formed.

#### A4.7. Ion chromatography

##### *Advantages*

This technique can be used for the measurement of both anions and cations; in such cases, the use of two separate instruments is recommended.

Small sample volumes required, which means that small amounts of precipitation can be analysed successfully.

##### *Methods*

Use a known standard (e.g. CEN, ISO ...)

Follow the recommendations of the supplier and consult with other users concerning specific problems and techniques.

Analytical columns are expensive and easily damaged or destroyed: always use a pre-column.

##### *Calibration*

For  $Cl^-$ ,  $NO_3^-$ ,  $SO_4^{2-}$  (eluent  $CO_3^{2-}/HCO_3^-$ ) and  $NH_4^+$ , we recommend quadratic calibrations in the range of two orders of magnitude, obtained using at least five standards, two of which should be at the limits of the measurement interval.

For  $Cl^-$ ,  $NO_3^-$ ,  $SO_4^{2-}$  (eluent  $CO_3^{2-}/HCO_3^-$ ) and  $NH_4^+$ , linear calibrations should only be in the range of one order of magnitude, using at least three standards corresponding to the limits and the centre of the measurement interval.

The use of KOH as eluent improves the linearity for  $Cl^-$ ,  $NO_3^-$  and  $SO_4^{2-}$ .

For  $Na^+$ ,  $K^+$ ,  $Mg^{2+}$  and  $Ca^{2+}$ , linear calibrations (with at least three standards) up to two orders of magnitude may be used.

The standards used in calibration must cover the values of the samples analysed.

##### *Measurement*

Calibrate and analyse the samples only when the instrument is stable (after one hour's operating time at least).

After the initial calibration, a new calibration or a control standard measurement should be performed every 20-30 samples; more frequent calibrations do not appear to be necessary.

End the batch of analysed samples with a complete calibration - compare it with the previous one in order to check for drift.

Analyse every day at least one sample of ultrapure water (blank) and at least one control chart sample.

#### *General*

Take care to avoid contamination during preparation of the samples: perspiration on one's fingers contains appreciable amounts of NaCl. This is a common and well known problem, but often forgotten.

We advise using the autosampler to optimise the analysis time and to programme the analysis of batches of samples including calibration, blank, control chart, 20-30 samples, calibration or control standard, 20-30 samples etc. The use of manual injections does not seem to affect the quality of the analyses.

Two injections per sample or standard are not essential. However, the main causes of errors are to be found in incorrect calibration, contamination during the handling of samples and standards etc.

When analysing samples with a low ionic content, it is advisable to use injection loops of 100 µl or more.

Careful quality control must be designed specifically for ion chromatography analysis, even when using external quality controls (certified reference materials) to limit the occurrence of systematic errors.

#### *Practical experience*

Separation of the Na<sup>+</sup> and NH<sub>4</sub><sup>+</sup> peaks needs to be improved. Because NH<sub>4</sub><sup>+</sup> elutes after the Na<sup>+</sup> peak, some columns reduce the tailing.

An increase in the inlet pressure is usually due to the clogging of the inlet frit. Never try to clean it, but discard it and replace with a new one.

The connecting tubes and sampling loop of some equipment can adsorb and release Ca<sup>2+</sup> ions; this is often indicated by unusually high Ca controls. If the problem is not due to the quality of the eluent, replace the injection loop and, if the problem persists, the tubing inlet to the detector.

Care should be taken when analysing anions and cations on the same system, as the individual eluents are usually incompatible. The system should be carefully rinsed and tested.

### **A4.8 Methods that give a high dispersion of results**

Some methods give a high dispersion of results, and are thus not recommended for use in the monitoring programme. These methods are summarised in Table A4.4. See also Mosello et al. (2002) and Marchetto et al. (2006).

**Table A4.4: Analytical methods that frequently give high dispersion of results.**

Analyte	Methods
Alkalinity (low values)	Acidimetric titration with colorimetric detection of the end-point Acidimetric titration with single fixed end point without correction
Sulphate	Turbidimetry Spectrophotometry with BaSO <sub>4</sub> excess and methyl thymol Continuous flow analysis with BaSO <sub>4</sub> excess and methyl thymol
Nitrate (in samples with high DOC)	Spectrophotometry with UV detection at 220 nm
Chloride	AgNO <sub>3</sub> titration with K <sub>2</sub> CrO <sub>4</sub> indicator
Ca and Mg	EDTA titration
Ammonium	Nessler spectrophotometric method Ion selective electrode
Total Nitrogen	Kjeldahl digestion Alkaline persulphate digestion (K <sub>2</sub> S <sub>2</sub> O <sub>8</sub> and NaOH, PSOH)
Total Sulphur	ICP MS
Aluminium	AAS Flame
DOC	Spectrophotometry with detection at 320 nm



## Annex 5: List of ISO and CEN methods

to be used for the analysis and QA/QC laboratory procedures.

See also Ellis and Williams (2012).

CEN or ISO n°	Name of standard
ISO 7150/1	Water quality – determination of ammonium – part 1: manual spectrometric method (recommended to be used for soil solution only)
ISO 7150/2	Water quality – determination of ammonium – part 2: automated spectrometric method
ISO 7888	Water quality – determination of electrical conductivity
ISO 8245	Water quality – guidelines for the determination of total organic carbon (TOC) and dissolved organic carbon (DOC)
ISO 8258	Shewhart control charts
ISO 9963-1	Water quality – determination of alkalinity – part 1: determination of total and composite alkalinity
ISO 9963-2	Water quality – determination of alkalinity – part 2: determination of carbonate alkalinity
ISO 10523	Water quality – determination of pH
ISO 11732	Water quality – determination of ammonium nitrogen by flow analyses (CFA and FIA) and spectrometric detection
ISO 11885	Water quality – determination of selected elements by inductively coupled plasma atomic emission spectroscopy
ISO 10304-1	Water quality – determination of dissolved fluoride, chloride, nitrite, orthophosphate, bromide, nitrate and sulphate ions, using liquid chromatography of ions – part 1: method for water with low contamination
ISO 10304-4	Water quality – determination of dissolved anions by liquid chromatography of ions – part 4: determination of chlorate, chloride and chlorite in water with low contamination
ISO/TR 13530	Water quality – guide to analytical quality control for water analysis
ISO 14911	Water quality – determination of dissolved Li <sup>+</sup> , Na <sup>+</sup> , NH <sub>4</sub> <sup>+</sup> , K <sup>+</sup> , Mn <sup>2+</sup> , Ca <sup>2+</sup> , Mg <sup>2+</sup> , Sr <sup>2+</sup> and Ba <sup>2+</sup> using ion chromatography – method for water and waste water
ISO 9964-1:1993	Water quality -- Determination of sodium and potassium -- Part 1: Determination of sodium by atomic absorption spectrometry
ISO 7980:1986	Water quality -- Determination of calcium and magnesium -- Atomic absorption spectrometric method
ISO 9964-2:1993	Water quality -- Determination of sodium and potassium -- Part 2: Determination of potassium by atomic absorption spectrometry
ISO 15682	Water quality : chloride determination with CFA or FIA with photometric or potentiometric determination
ISO 12020:1997	Water quality -- Determination of aluminium -- Atomic absorption spectrometric methods
ISO 9174:1998	Water quality -- Determination of chromium -- Atomic absorption spectrometric methods
ISO 15586	Water quality -- Determination of trace elements using atomic absorption spectrometry with graphite furnace
ISO 5961: 1994	Water quality -- Determination of cadmium by atomic absorption spectrometry
ISO 8288:1986	Water quality -- Determination of cobalt, nickel, copper, zinc, cadmium and lead -- Flame atomic absorption spectrometric methods
ISO/IEC 17025:2005	General requirements for the competence of testing and calibration laboratories

## Annex 6: Oxidation of Mercury – Addition of bromine chloride and hydrochloric acid

For the measurement of mercury (Hg), samples must be added with as much bromine chloride (BrCl) ( $c(\text{Br}_2) = 0.05 \text{ mol/l}$ ) and HCl ( $w/w = 37 \%$ ) as necessary for an end concentration in the samples of 0.5 % (v/v) for BrCl and 1 % (v/v) for HCl.

Therefore, all sample bottles for mercury measurement have to be weighed in the lab before deployed in the field and after sampling to determine the amount of precipitation. If the amount of precipitation is less than 100 ml ultrapure water is added with a squeeze bottle to fill up the total amount of solution in the sample bottle to 200 ml.

Afterwards and in case the total amount of precipitation is greater than 100 ml, 1 ml of Hydrochloric acid and 0.5 ml of Bromine-Solution is added for every 100 ml of solution by a dispenser (e.g. Fortuna Optifix Safety 2-10 ( $\pm 60 \mu\text{l}$ ) or 1-5 ml ( $\pm 30\mu\text{l}$ )).

For the first 200 ml no hydrochloric acid has to be added.

### Example 1:

Mass of the container and 100 ml 2 % v/v HCl before sampling: 705 g

Mass of the container after sampling: 2785 g

Amount of precipitation:  $2785 \text{ g} - 705 \text{ g} = 2080 \text{ g}$

No water needs to be added

Amount of HCl:  $2080 \text{ g} - 200 \text{ g} = 1880 \text{ g}$  (equivalent to 1880 mL)

$1880 \text{ mL} / 100 = 18.8 \text{ mL}$  HCl has to be added

Amount of Bromine Solution:  $2080 \text{ mL} / 100 * 0.5 = 10.4 \text{ ml}$  bromine solution has to be added.

### Example 2:

Mass of the container and 100ml 2 % v/v HCl before sampling: 705 g

Mass of the container after sampling: 785 g

Amount of precipitation:  $785 \text{ g} - 705 \text{ g} = 80 \text{ g}$

Total amount of solution is less than 200 ml; water has to be added:  $200 \text{ g} - \text{Amount of precipitation} - \text{HCl in the bottle} \Rightarrow 200 \text{ g} - 80 \text{ g} - 100 \text{ g} = 20 \text{ g}$  (equivalent 20 ml) of Ultrapure water is added with a squeeze bottle

Amount of HCl: no HCl has to be added

Amount of Bromine Solution:  $200 \text{ ml} / 100 * 0.5 = 1 \text{ ml}$  bromine solution has to be added.

## Annex 7: Interpretation of the throughfall data

Some details on data evaluation of throughfall and precipitation results are given below. Further details are given in Draaijers et al., 1998.

**Sulphur**      Throughfall (plus stemflow) are in most areas of Europe representative for the total deposition to the forest. Some questions remain about throughfall data in very low-polluted areas.

Dry deposition (including contributions from fog/cloud water deposition, can be calculated as the difference between throughfall and wet deposition. This difference is also called net throughfall. For this purpose, wet deposition should ideally be measured using wet-only collectors.

However in areas where very low dry deposition contributions are obtained to the bulk collector, also bulk deposition data are possible to use. In areas with a high fog frequency, fog and cloud water deposition can be measured optionally and be separated from the dry deposition part of the net throughfall.

**Nitrogen**      Oxidised, reduced and organic nitrogen is analysed separately in throughfall and stemflow. The sum of these compounds is the total nitrogen in the throughfall plus stemflow flux.

Total nitrogen in throughfall and stemflow can be compared to the total nitrogen (mainly nitrate and ammonium) in wet deposition. In areas with a low nitrogen load, the throughfall plus stemflow nitrogen flux is often lower than the wet deposition due to high canopy up-take. This means that nitrogen fluxes in throughfall plus stemflow systematically underestimate deposition fluxes. In areas with high throughfall deposition, evidence of high nitrogen load to the soil is also indicated by e.g. leaching of nitrate to soil water.

The total nitrogen deposition from the atmosphere to the forest includes also the amount of gaseous nitrogen compounds taken up by vegetation via stomata and the amount of nitrogen deposited to the tree surface, and taken up by the tree or by lichens, algae and other organisms. Today there are no generally validated procedures to estimate the amount taken up by the tree.

A recommended procedure to make a rough estimate of nitrogen deposition is given in Annex 1.

Optionally total nitrogen deposition with fog and cloud water can be determined by separate measurements.

Base cations      The main source of sodium is atmospheric deposition of sea salt. The sodium in throughfall is considered to be a good measure of the total sodium deposition.

Magnesium, calcium and potassium can be derived from both leaching and atmospheric deposition. This means that base cation deposition is smaller than the measured throughfall plus stemflow fluxes. There are several approaches used today to separate the contributions from the two processes. However, these so called canopy budget models need accurate monitoring data. A good knowledge of the nutrient status etc. of the forest stand is valuable for the interpretation of results. Canopy budget approaches used in Europe and the USA are presented in Annex 1.

## Annex 8: Minor changes after 2022

Date	Minor change to latest published version in 2022	Affected sections of this document